

SPECTRACOOL NARROW COMPACT INDOOR

N16 115/230 Volt
800 BTU/Hr.
234 Watt

N21 115/230 Volt
2000 BTU/Hr.
586 Watt

INDUSTRY STANDARDS

UL/cUL Listed; Type 12, 3R, 4, 4X optional; File No. SA6453 UR/cUR Recognized on select models for N16 and N21

CE
 IP 54 Internal Loop
 IP 34 External Loop
 EAC
 Telcordia GR-487 capable (Outdoor)
 Reference performance data tables for agency approvals applied to each model.

APPLICATION

- Industrial automation
- Package handling equipment
- Security and defense systems

FEATURES

- Narrow design accommodates 12-in. deep cabinets
- R134a earth-friendly refrigerants
- Models for 115, 230 and 400/460 VAC power input
- UL Listed to save customers time and money with agency approvals
- Attractive industrial design with minimal use of visible fasteners
- Reliable mechanical thermostat is located behind the cover of the unit; Air Conditioner models include digital display on ambient side
- Galvanized sheet-metal cover for rugged factory and outdoor environments
- Easy-mount flanges for simple installation
- Cutout adapter options for enclosures with GENESIS air conditioners enable users to easily transition to the new unit
- Dust-resistant condenser coil allows the unit to be run filterless in most applications
- Cleanable, reusable aluminum mesh filter protects coils for maximum cooling performance
- Mounting hardware, gaskets and user manual furnished with the unit
- Every unit functionally tested before shipping
- Standard Indoor Air Conditioner models also include:
 - Active condensate management
 - Power-off relay for door switch and other system requirements
 - Malfunction switch

SPECIFICATIONS

- Nominal cooling capacity:
 - N16 800 BTU/Hr. (234 W)
 - N21 2000 BTU/Hr. (586 W)
- Operating temperature range from 50 F/10 C to 125 F/52 C

FINISH

- RAL 7035 light-gray, semi-textured powder-coat paint
- Other colors and textures available

Performance Data **N16 800 BTU/Hr. (234 Watt) Models**

CATALOG NUMBER		
Indoor Model	N160116G050	N160126G050
Indoor Model Stainless Steel Type 4X	N160116G051	N160126G051
Indoor Model with Remote Access Control*	N160116G060	N160126G060
COOLING PERFORMANCE		
Nominal:		
BTU/Hr.	800/800	800/900
Watts	235/235	235/264
At 131 F/131 F (55 C/55 C):		
BTU/Hr. (50/60 Hz)	819	920/960
W (50/60 Hz)	240	270/281
At 95 F/95 F (35 C/35 C):		
BTU/Hr. (50/60 Hz)	948	810/955
W (50/60 Hz)	278	237/280
Refrigerant	R134A	R134A
Refrigerant Charge (ounces/grams)	4/113	3.8/107
Operating Temperature Range:		
Maximum (°F/°C)	131/55	125/131/52/55
Minimum (°F/°C)	-40/-40	-40/-40
Airflow at 0 Static Pressure:		
Internal loop 50 Hz (CFM / m ³ /hr.)	25/42	25/42
External loop 50 Hz (CFM / m ³ /hr.)	48/82	48/82
Internal loop 60 Hz (CFM / m ³ /hr.)	30/51	30/51
External loop 60 Hz (CFM / m ³ /hr.)	53/90	53/90
Max. Heater W (Outdoor Models)	150	150
ELECTRICAL DATA		
Rated Voltage	100/115	220/230
Frequency (Hz)	50/60	50/60
Operating Range	+/- 10%	+/- 10%
Max. Power Consumption (W at 50/60 Hz)	360/403	330/345
Max. Nominal Current (A at 50/60 Hz)	3.6/3.5	1.5/1.5
Starting Current (A)	8.0/9.2	3.3/3.1
Agency Approvals	cUL Listed CE EAC Others available upon request	
Power Input Description	Terminal Block	Terminal Block
ENCLOSURE PROTECTION		
UL Type	Type 12, 3R, 4 standard Type 4X Stainless steel optional	
CONTROLLER		
Description	Basic mechanical thermostat	
Thermostat Location	Enclosure behind front panel	
Factory Thermostat Setting (°F/°C)	80/27	
SOUND LEVEL		
At 1.5 Meters	63 dB(A)	
UNIT CONSTRUCTION		
Material	Galvanized sheet metal standard Stainless steel optional	
Finish	RAL 7035 light-gray, semi-textured powder-coat paint standard	
UNIT DIMENSIONS		
Height (in./mm)	16.51/419	
Width (in./mm)	7.52/191	
Depth (in./mm)	6.30/160	
Weight (lb./kg)	27/12	

*Units with Remote Access Control utilize a digital controller and communicate via EtherNet/IP, Profinet, Modbus TCP/IP and SNMP over ethernet or modbus RTU over USB.

Performance Curves for N16 Models 800 BTU/Hr. (234 Watt)

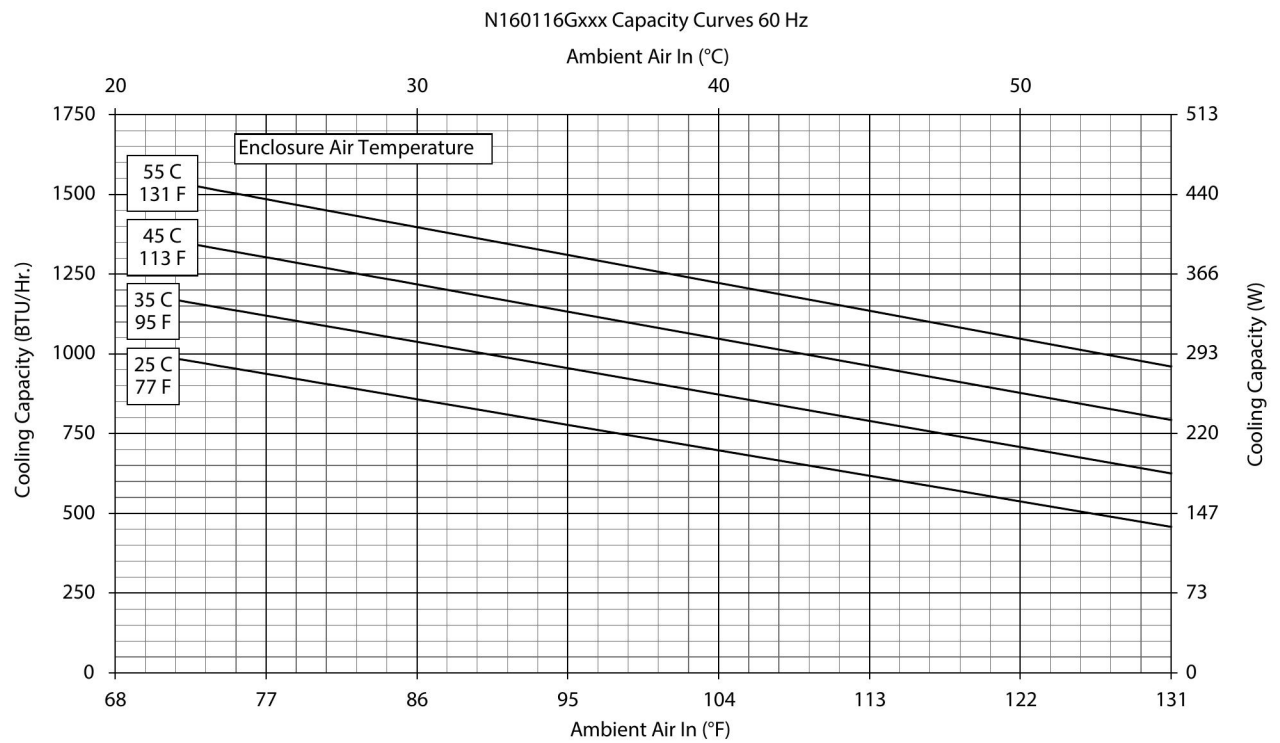
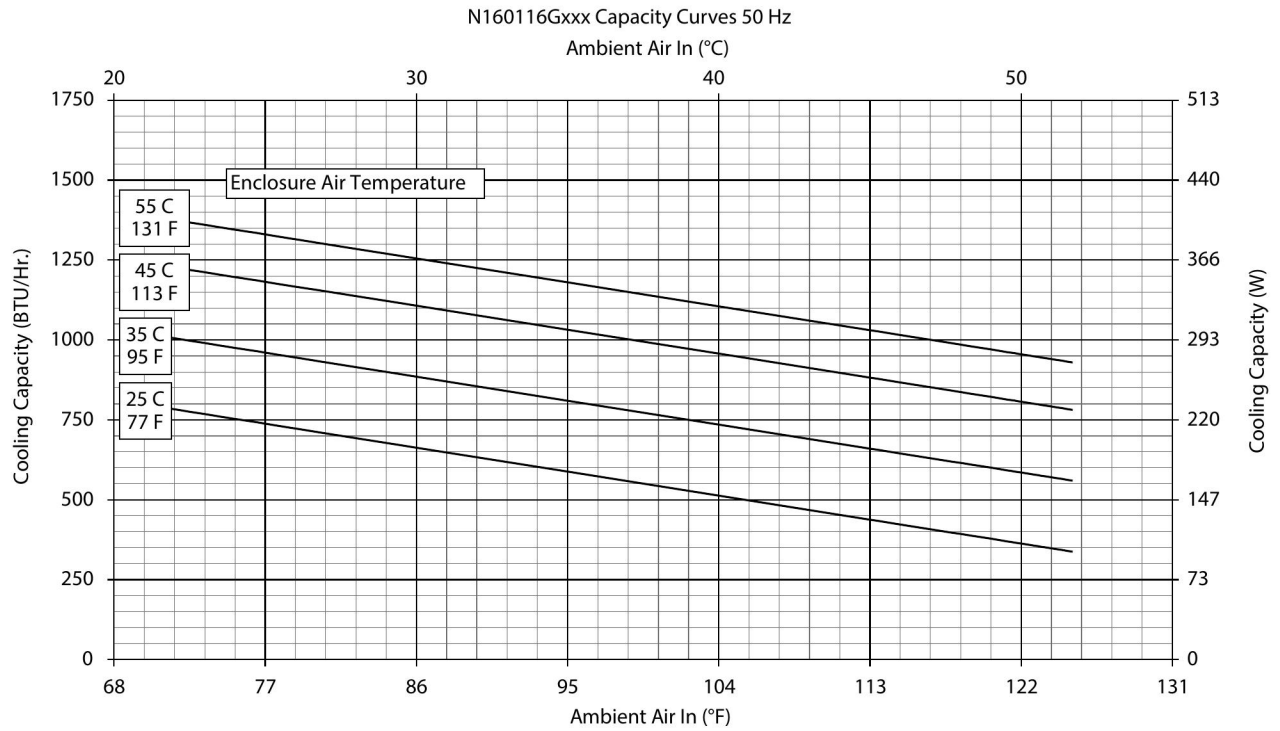

Performance Curves for N16 Models 800 BTU/Hr. (234 Watt)

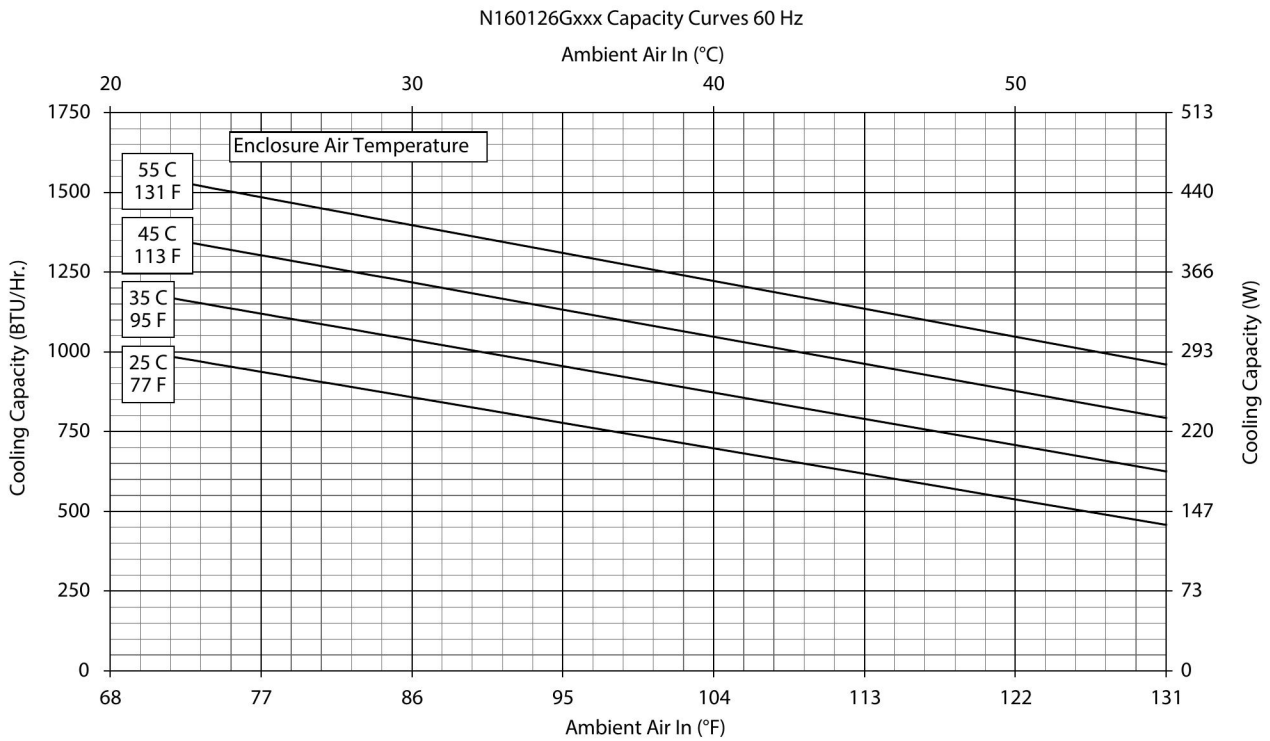
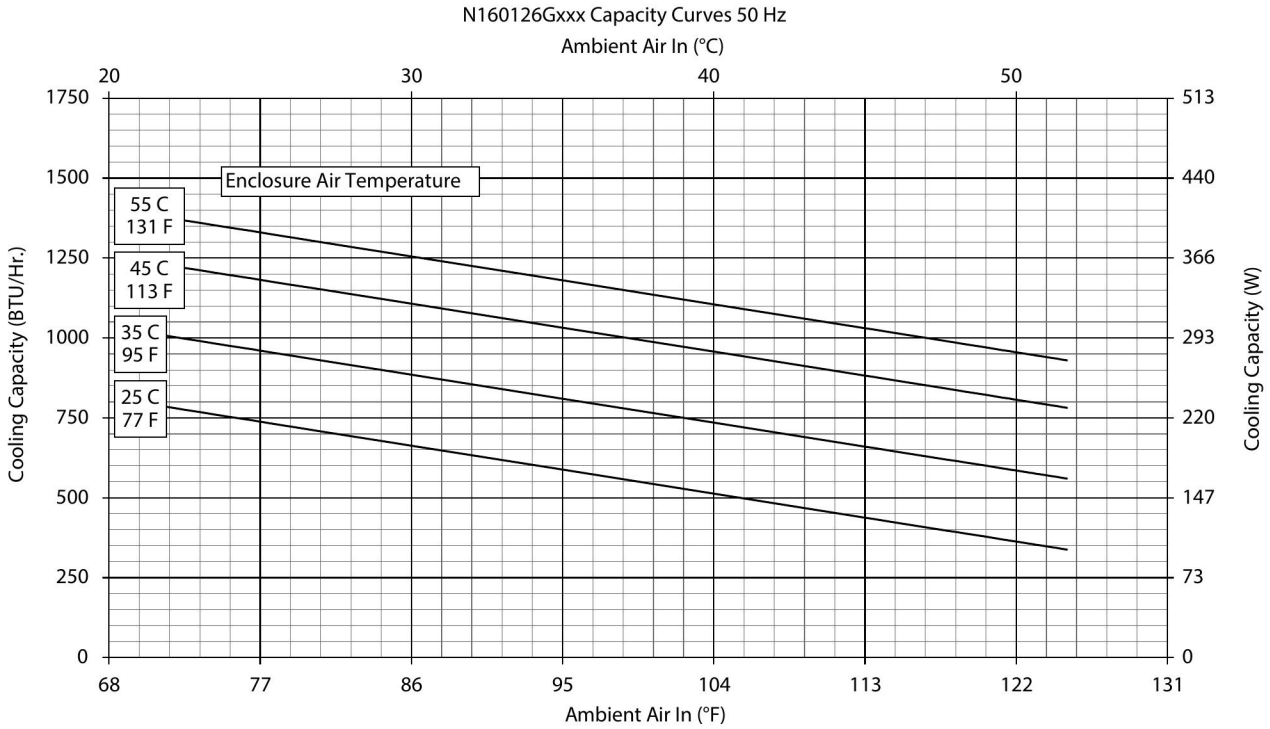

N16 800 BTU/Hr. (234 Watt)

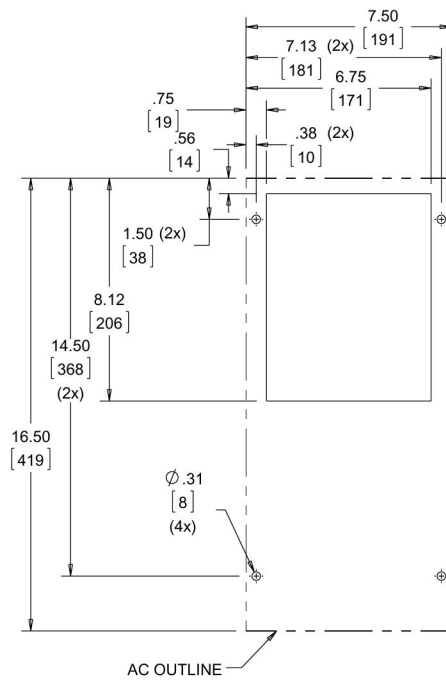
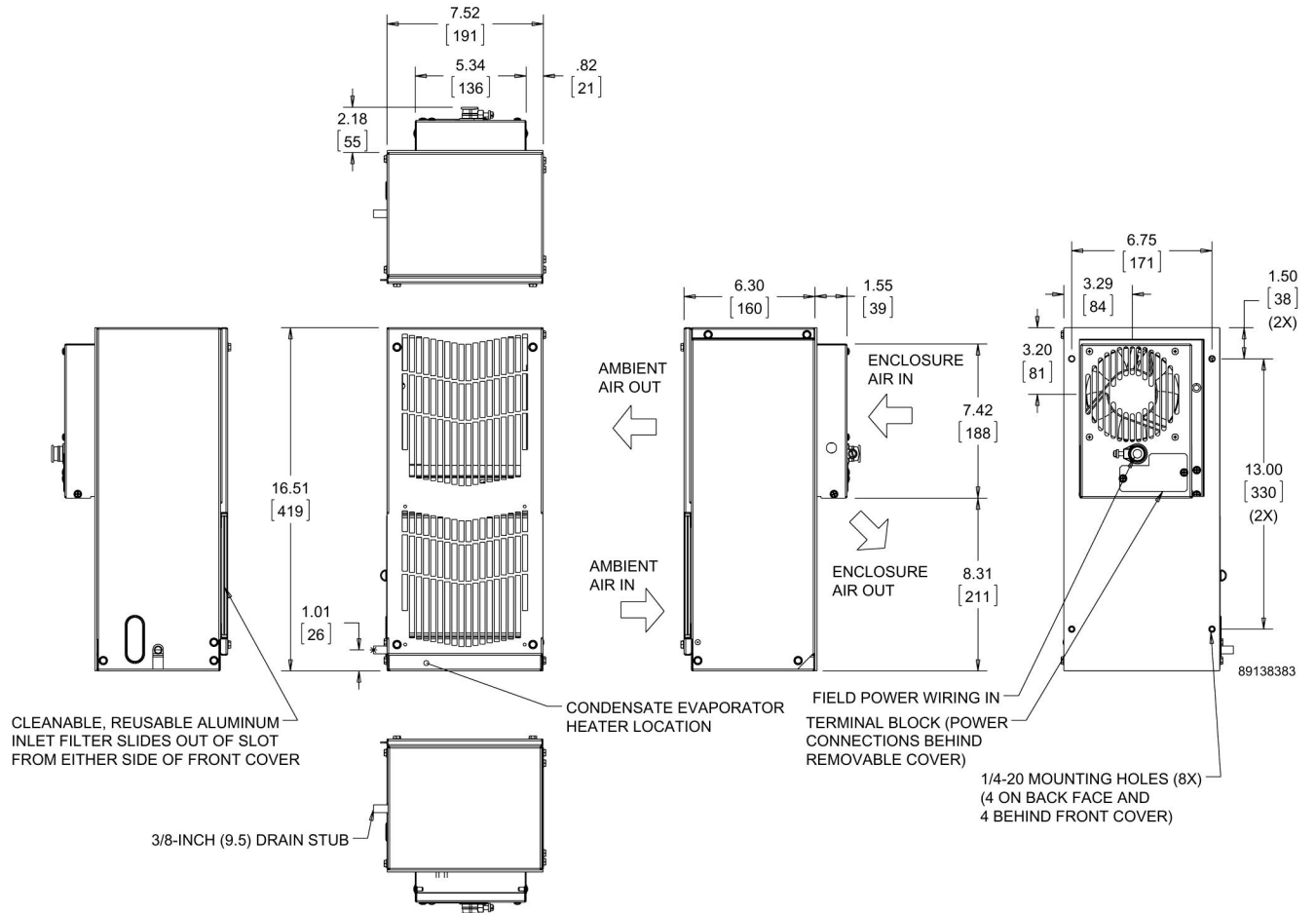

Cutout Dimensions (Externally Mounted)

Visit www.nVent.com/HOFFMAN to download 2D and 3D CAD drawings into the overall design of your electrical system.

Performance Data **N21 2000 BTU/Hr. (586 Watt) Models**

CATALOG NUMBER			
Indoor Model	N210216G050	N210226G050	N210246G050
Indoor Model Stainless Steel Type 4X	N210216G051	N210226G051	N210246G051
Indoor Model with Remote Access Control*	N210216G060	N210226G060	N210246G060
COOLING PERFORMANCE			
Nominal:			
BTU/Hr.	1800/2000	1800/2000	1800/2000
Watts	528/586	528/586	528/586
At 131 F/131 F (55 C/55 C):			
BTU/Hr. (50/60 Hz)	2000/2175	2000/2175	2000/2175
W (50/60 Hz)	586/637	586/637	586/637
At 95 F/95 F (35 C/35 C):			
BTU/Hr. (50/60 Hz)	1950/2200	1950/2200	1950/2200
W (50/60 Hz)	571/645	571/645	571/645
Refrigerant	R134A	R134A	R134A
Refrigerant Charge (ounces/grams)	6.5/184	6.5/184	6.5/184
Operating Temperature Range:			
Maximum (°F/°C)	131/55	131/55	131/55
Minimum (°F/°C)	-40/-40	-40/-40	-40/-40
Airflow at 0 Static Pressure:			
Internal loop 50 Hz (CFM / m ³ /hr.)	77/131	77/131	77/131
External loop 50 Hz (CFM / m ³ /hr.)	150/255	150/255	150/255
Internal loop 60 Hz (CFM / m ³ /hr.)	91/155	91/155	91/155
External loop 60 Hz (CFM / m ³ /hr.)	165/280	165/280	165/280
Max. Heater W (Outdoor Models)	500	500	500
ELECTRICAL DATA			
Rated Voltage	115	230	460V 1PH
Frequency (Hz)	50/60	50/60	50/60
Operating Range	+/- 10%	+/- 10%	+/- 10%
Max. Power Consumption (W at 50/60 Hz)	700/805	805	874
Max. Nominal Current (A at 50/60 Hz)	7.0/7.0	3.5/3.5	1.9
Starting Current (A)	19	7.6	7.2
Agency Approvals	cUL Listed CE EAC		cUR Recognized CE EAC
Others available upon request			
Power Input Description	Terminal Block	Terminal Block	Terminal Block
ENCLOSURE PROTECTION			
UL Type	Type 12, 3R, 4 standard Type 4X Stainless steel optional		
CONTROLLER			
Description	Basic mechanical thermostat		
Thermostat Location	Enclosure side on all base models		
Factory Thermostat Setting (°F/°C)	80/27		
SOUND LEVEL			
At 1.5 Meters	66 dB(A)		
UNIT CONSTRUCTION			
Material	Galvanized sheet metal standard Stainless steel optional		
Finish	RAL 7035 light-gray, semi-textured powder-coat paint standard Other colors available		
UNIT DIMENSIONS			
Height (in./mm)	20.92/531	20.92/531	25.17/614
Width (in./mm)	10.00/254	10.00/254	10.00/254
Depth (in./mm)	9.90/251	9.90/251	9.90/251
Weight (lb./kg)	56/25	56/25	66/30

*Units with Remote Access Control utilize a digital controller and communicate via EtherNet/IP, Profinet, Modbus TCP/IP and SNMP over ethernet or modbus RTU over USB.



Performance Curves for N21 Models 2000 BTU/Hr. (586 Watt)

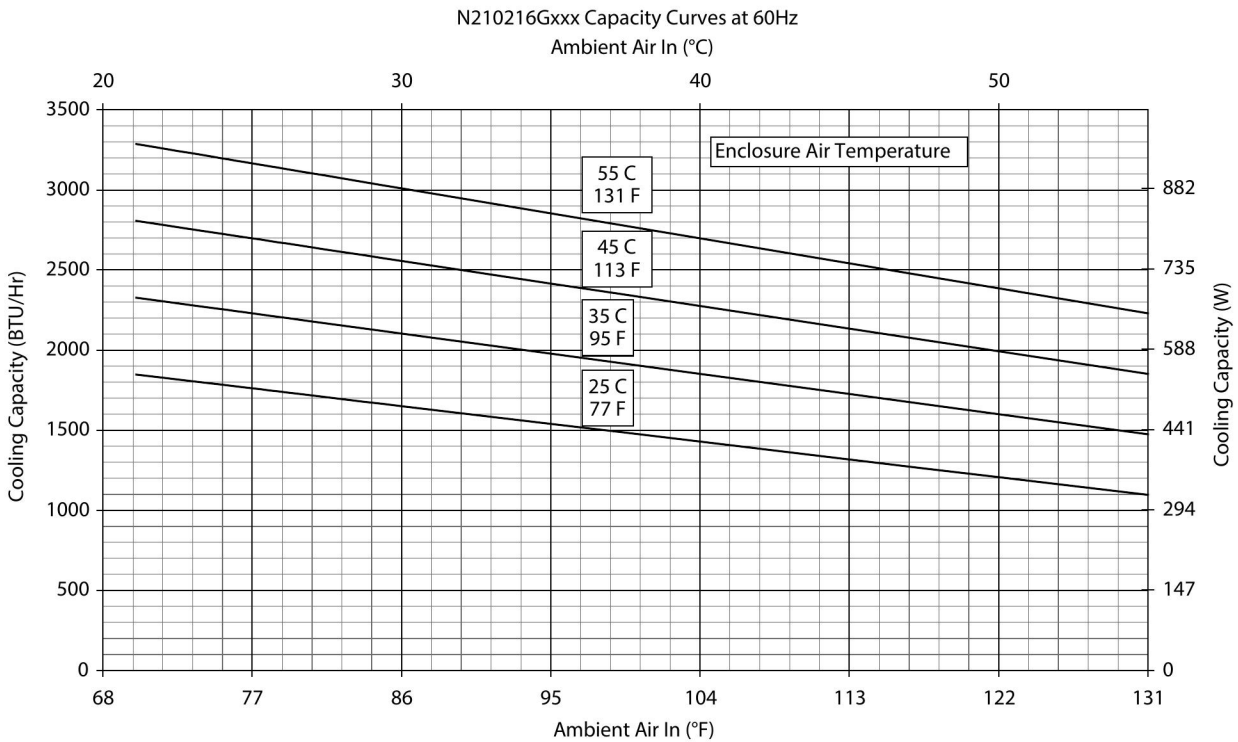
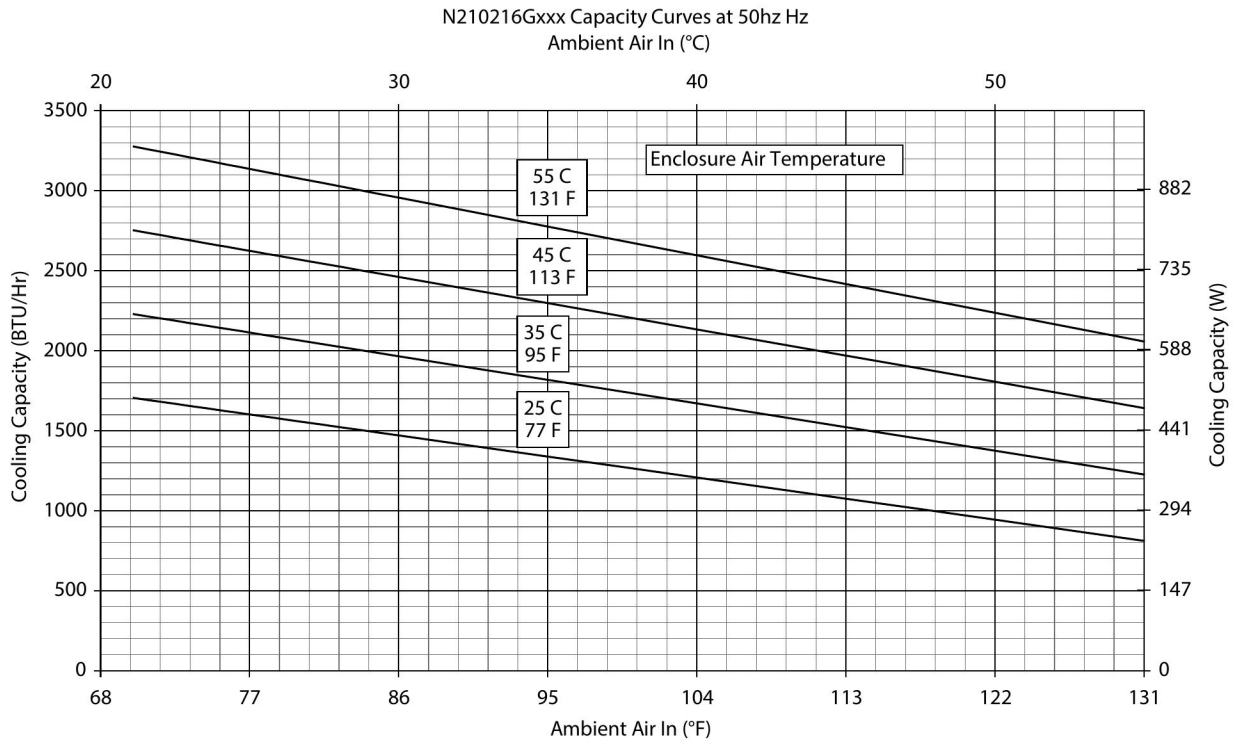

Performance Curves for N21 Models 2000 BTU/Hr. (586 Watt)

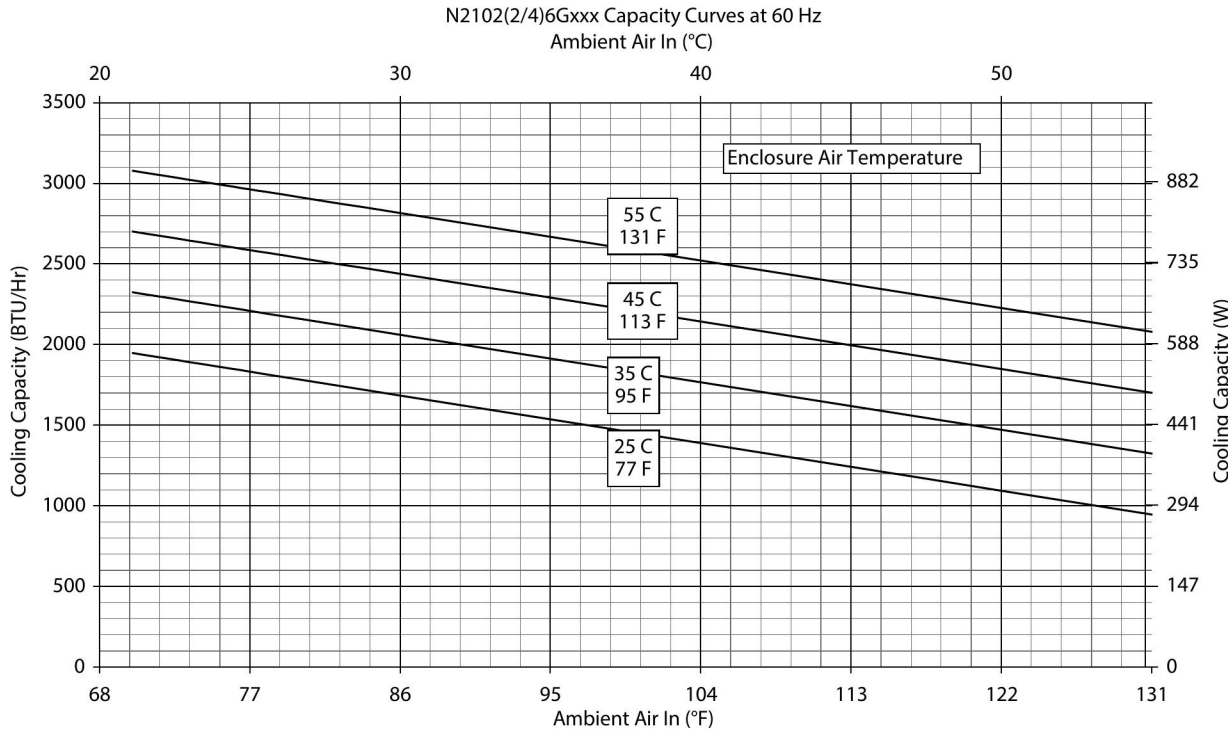
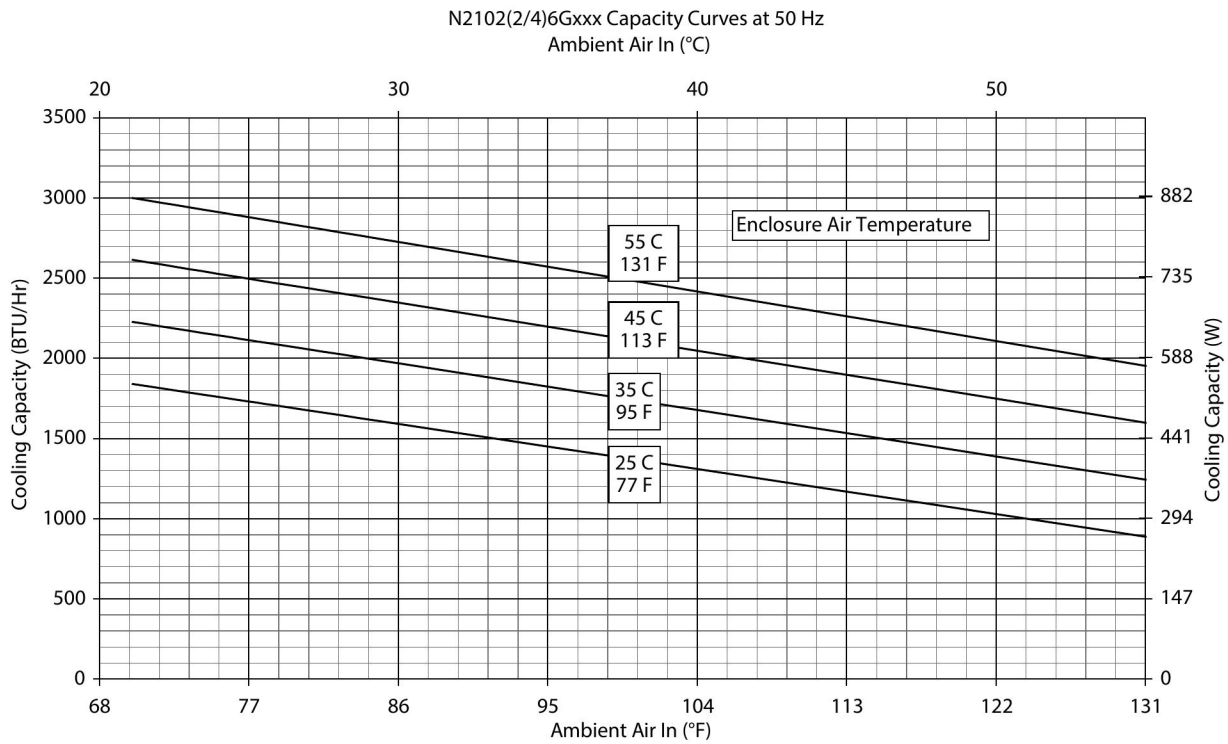

N21 115/230V Models 2000 BTU/Hr. (586 Watt)

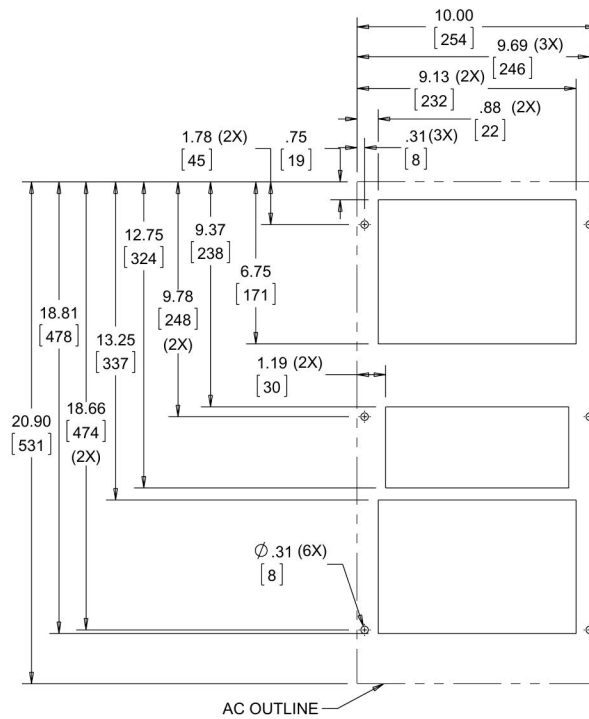
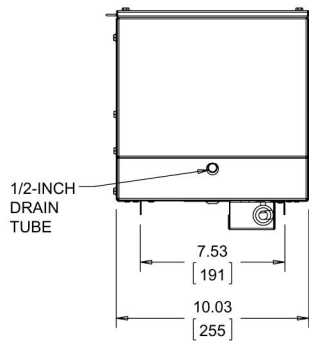
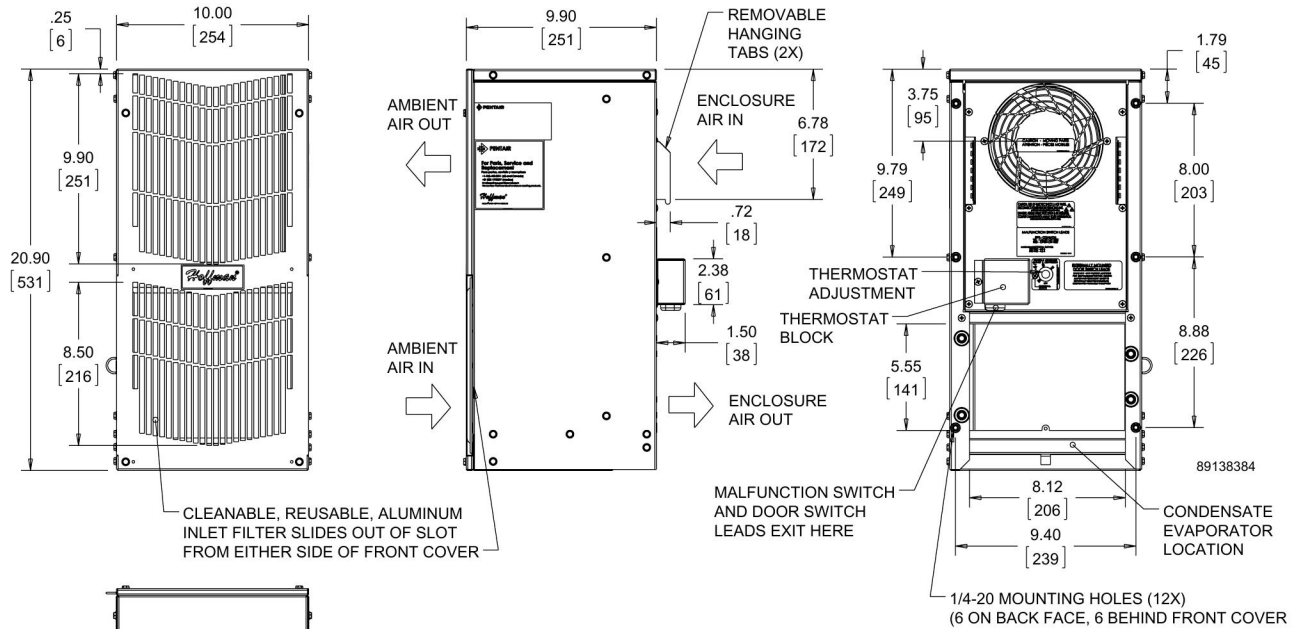

Visit www.nVent.com/HOFFMAN to download 2D and 3D CAD drawings into the overall design of your electrical system.

N21 460V Models 2000 BTU/Hr. (586 Watt)

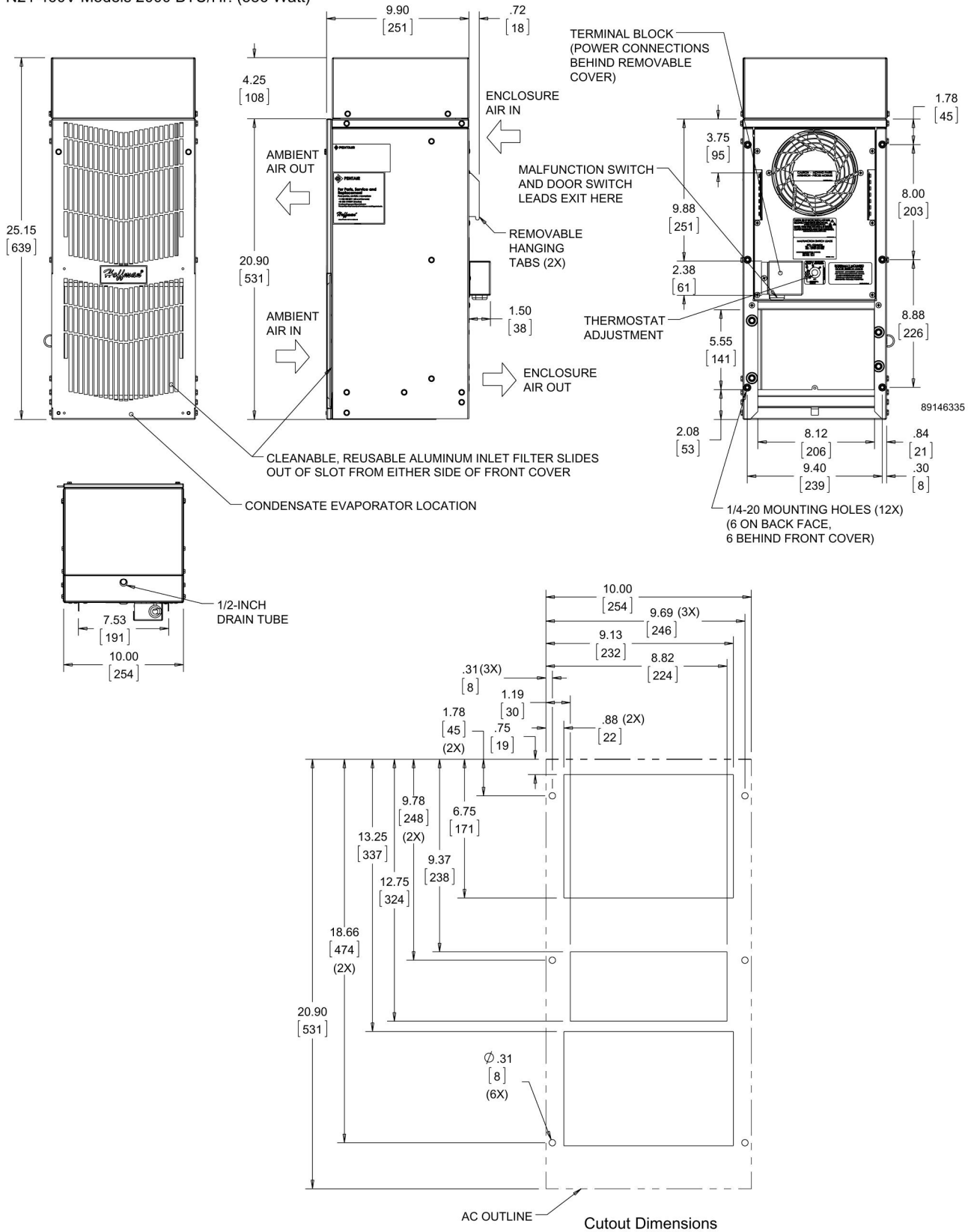

Visit www.nVent.com/HOFFMAN to download 2D and 3D CAD drawings into the overall design of your electrical system.

SPECTRACOOl NARROW INDOOR/OUTDOOR

N43	N36	N28
11000 BTU/Hr.	6000/8000 BTU/Hr.	4000 BTU/Hr.
3223 Watt	1758/2344 Watt	1172 Watt

INDUSTRY STANDARDS

UL/cUL Listed; Type 12, 3R, 4; 4X optional; File No. SA6453

CE
 IP 56 Internal Loop
 IP 34 on External Loop
 Telcordia GR-487 capable (Outdoor)

APPLICATION

- Industrial automation
- Waste water treatment systems
- Package handling equipment
- Security and defense systems

FEATURES

- Narrow design accommodates 12-in. (300-mm) deep cabinets
- Energy efficient reciprocating compressor on N28 models
- Energy efficient rotary compressor on N36 and N43 models
- R407c and R134a earth-friendly refrigerants
- Models for 115, 230 and 400/460 3-phase VAC power input
- UL Listed to save customers time and money with agency approvals
- Outdoor model operating temperature range from -40 F/-40 C to 131 F/55 C (125 F/52 C on N28 Series)
- Attractive industrial design with minimal use of visible fasteners
- Reliable mechanical thermostat on enclosure side of the unit; indoor Air Conditioner models include digital display on ambient side
- Galvanized sheet-metal cover for rugged factory and outdoor environments
- Easy-mount flanges for simple installation
- Cut-out adapter options for enclosures with GENESIS air conditioners enable users to easily transition to the new unit
- Dust-resistant condenser coil allows the unit to be run filterless in most applications
- Cleanable, reusable aluminum mesh filter protects coils for maximum cooling performance
- Mounting hardware, gaskets and user manual furnished with the unit
- Every unit functionally tested before shipping
- Standard Indoor Air Conditioner models also include:
 - Active condensate management with heater strip
 - Power-off relay for door switch and other system requirements
 - Malfunction switch
- Standard Outdoor Air Conditioner models also include:
 - Telcordia GR-487 capable
 - Corrosion-resistant components
 - Malfunction switch
 - Compressor heater
 - Head pressure control
 - 1300 W enclosure heater

SPECIFICATIONS

- Nominal cooling capacity:
 - N28 4000 BTU/Hr. (1172 W)
 - N36 6000 & 8000 BTU/Hr. (1758 and 2344 W)
 - N43 11000 BTU/Hr. (3223 W)
- Outdoor model operating temperature range from -40 F/-40 C to 131 F/55 C (125 F/52 C on N28 Series)

FINISH

- RAL 7035 light-gray, semi-textured powder-coat paint
- Other colors and textures available

Performance Data **N28 4000 BTU/Hr. (1172 Watt)**

CATALOG NUMBER			
Indoor Model	N280416G050	N280426G050	N280446G050
Indoor Model Stainless Steel Type 4X	N280416G051	N280426G051	N280446G051
Indoor Model with Remote Access Control*	N280416G060	N280426G060	N280446G060
Outdoor Model without Heat Pkg.	N280416G100	N280426G100	N280446G100
Outdoor Model with Heat Pkg.	N280416G150	N280426G150	-
Outdoor Model with Heat Pkg. Stainless Steel Type 4X	N280416G151	N280426G151	-
COOLING PERFORMANCE			
Nominal:			
BTUs/Hr.	3800 / 4000	3800 / 4000	3800 / 4000
Watts	1114 / 1172	1114 / 1172	1114 / 1172
At 125 F / 125 F (50 C / 50 C):			
BTU/Hr. (50 / 60 Hz)	3940 / 4104	4269 / 4703	4269 / 4703
Watts (50 / 60 Hz)	1150 / 1000	1250 / 1378	1250 / 1378
At 95 F / 95 F (35 C / 35 C):			
BTU/Hr. (50 / 60 Hz)	3754 / 4011	3700 / 4291	3700 / 4291
Watts (50 / 60 Hz)	1100 / 1175	1086 / 1257	1086 / 1257
Refrigerant	R134a	R134a	R134a
Refrigerant Charge (ounces/grams)	10 / 283	11 / 312	11 / 312
Operating Temperature Range:			
Maximum (°F / °C)	125 / 52	125 / 52	125 / 52
Minimum (°F / °C)	-40 / -40	-40 / -40	-40 / -40
Air Flow at 0 Static Pressure:			
Internal loop 50 Hz (CFM / M ³ /Hr)	138 / 234	138 / 234	138 / 234
External loop 50 Hz (CFM / M ³ /Hr)	268 / 455	268 / 455	268 / 455
Internal loop 60 Hz (CFM / M ³ /Hr)	143 / 243	143 / 243	143 / 243
External loop 60 Hz (CFM / M ³ /Hr)	288 / 489	288 / 489	288 / 489
Max. Heater W (Outdoor Models)	1300	1300	N/A
ELECTRICAL DATA			
Rated Voltage	110 / 115	230	460V 1PH
Frequency (Hz)	50 / 60	50 / 60	50 / 60
Operating Range	+/-10%	+/-10%	+/-10%
Max. Power Consumption (Watts at 50 / 60 Hz)	971 / 1116	975 / 1104	1104
Max. Nominal Current (Amps at 50 / 60 Hz)	10.1/11.2	4.9 / 5.0	2.5
Starting Current (Amps)	40	24.5	12.5
Agency Approvals		cUL Listed CE	
		Others available upon request	
Power Input Description		Terminal Block	
ENCLOSURE PROTECTION			
UL Type		Type 12, 3R, 4 Standard Type 4X Stainless Steel Optional	
CONTROLLER			
Description		Basic Mechanical Thermostat	
Thermostat Location		Enclosure Side	
Factory Thermostat Setting (°F / °C)		80 / 27	
SOUND LEVEL			
At 1.5 Meters	64.4 dBA	65.5 dBA	65.5 dBA
UNIT CONSTRUCTION			
Material		Galvanized sheet metal standard Stainless steel optional	
Finish		RAL 7035 light-gray, semi-textured powder-coat paint standard Other colors available	
ACCESSORIES			
EASYSWAP Adaptor Plenum (GENESIS M33)		Enables SPECTRACOOOL to be mounted to a GENESIS M33 air conditioner cutout Catalog Number PLM33N28	
UNIT DIMENSIONS			
Height (in / mm)		28 / 711.2	
Width (in / mm)		11.50 / 292.1	
Depth (in / mm)		14.00 / 355.6	
Weight (lb / kg)	84 / 38	84 / 38	92 / 41.7

*Units with Remote Access Control utilize a digital controller and communicate via EtherNet/IP, Profinet, Modbus TCP/IP and SNMP over ethernet or modbus RTU over USB.



Performance Curves for N28 Models 4000 BTU/Hr. (1172 Watt)

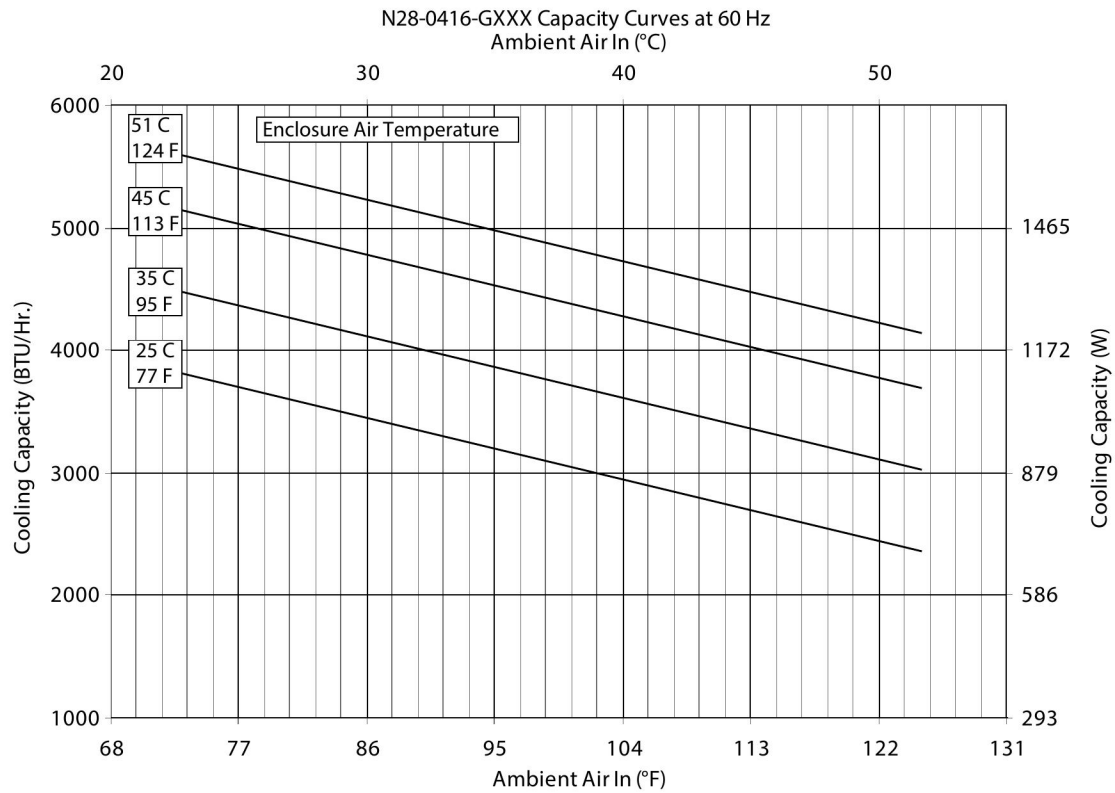
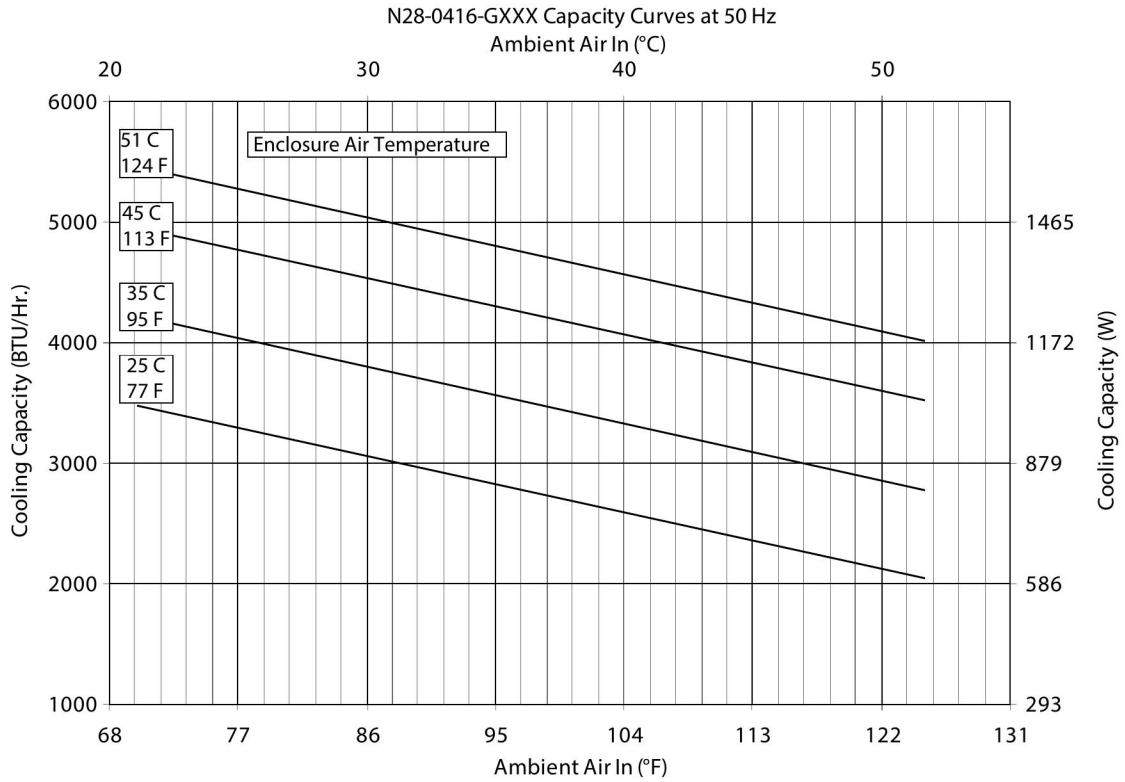

Performance Curves for N28 Models 4000 BTU/Hr. (1172 Watt)

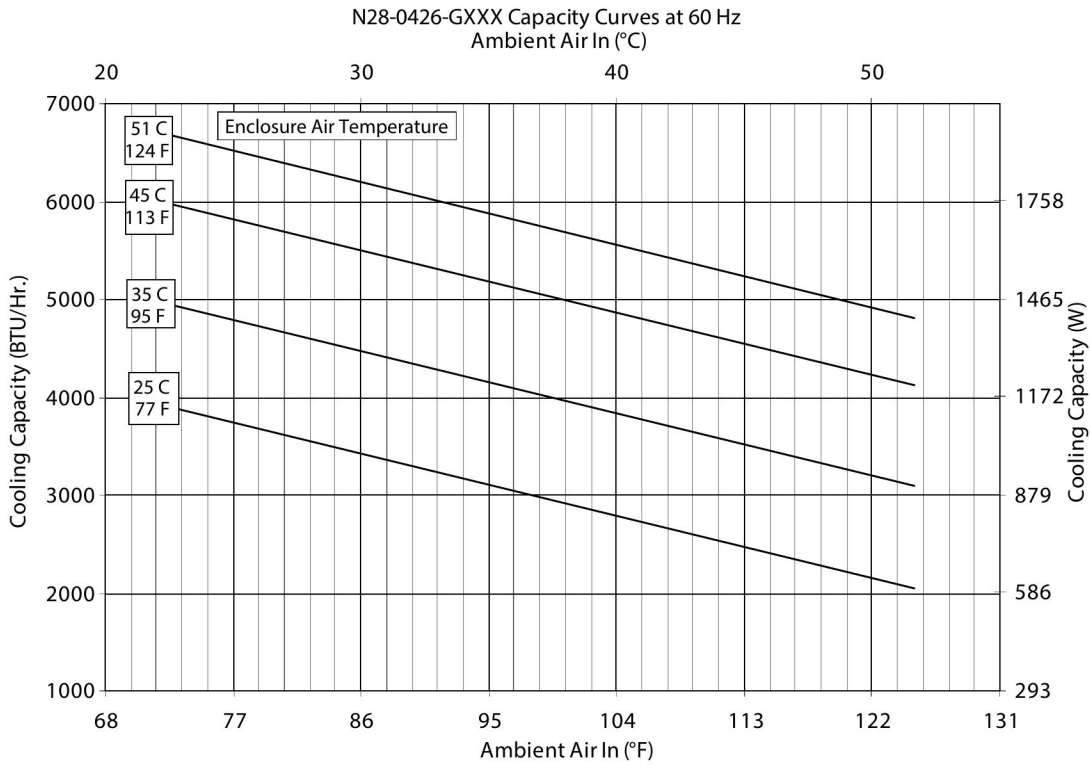
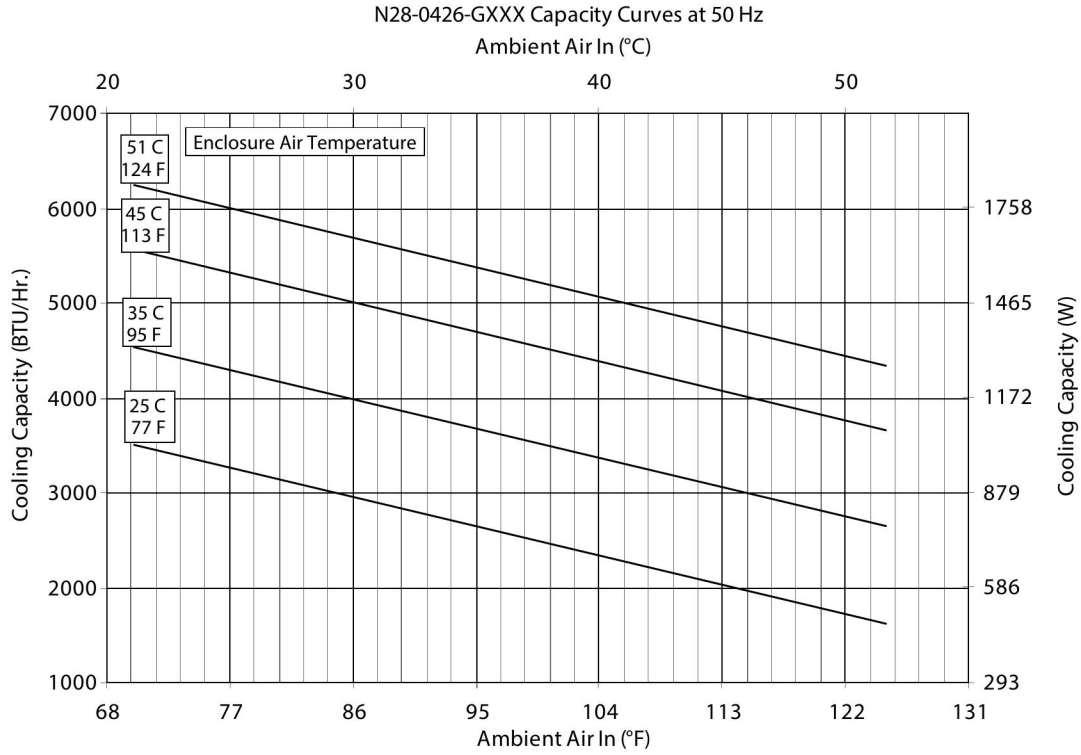

N28 Models 4000 BTU/Hr. (1172 Watt)

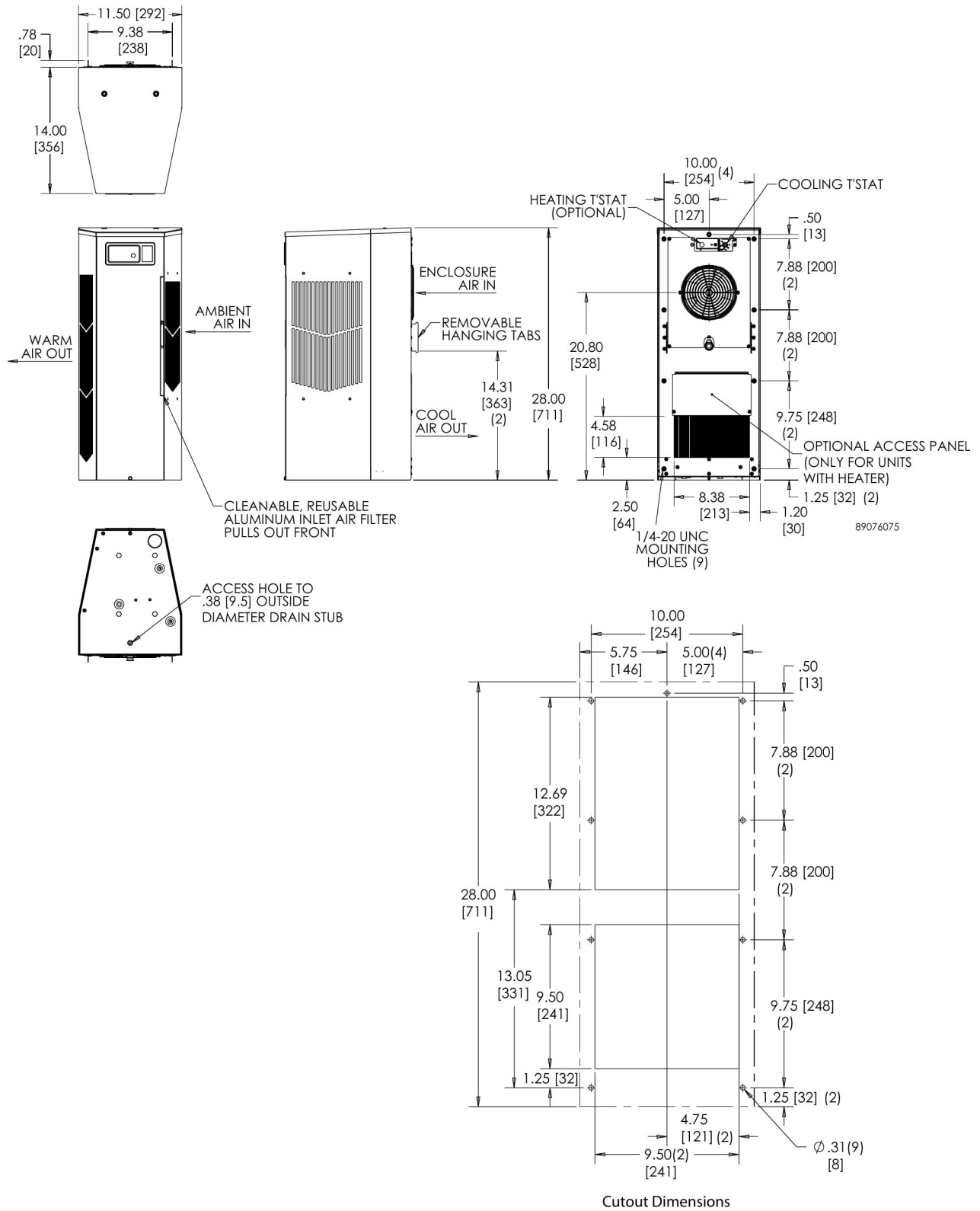

Visit www.nVent.com/HOFFMAN to download 2D and 3D CAD drawings into the overall design of your electrical system.

Performance Data **N36 6000/8000 BTU/Hr. (1758/2344 Watt)**

CATALOG NUMBER						
Indoor Model	N360616G050	N360626G050	N360646G050	N360816G050	N360826G050	N360846G050
Indoor Model Stainless Steel Type 4X	N360616G051	N360626G051	N360646G051	N360816G051	N360826G051	N360846G051
Indoor Model with Remote Access Control*	N360616G060	N360626G060	N360646G060	N360816G060	N360826G060	N360846G060
Outdoor Model without Heat Pkg.	N360616G100	N360626G100	N360646G100	N360816G100	N360826G100	N360846G100
Outdoor Model with Heat Pkg.	N360616G150	N360626G150	N360646G150	N360816G150	N360826G150	N360846G150
Outdoor Model with Heat Pkg. Stainless Steel Type 4X	N360616G151	N360626G151	N360646G151	N360816G151	N360826G151	N360846G151
COOLING PERFORMANCE						
Nominal:						
BTU/Hr.	5400 / 6000	5400 / 6000	5400 / 6000	8250 / 8500	8250 / 8500	8250 / 8500
Watts	1581 / 1757	1581 / 1757	1581 / 1757	2416 / 2489	2313 / 2635	2284 / 2401
At 131 F / 131 F (55 C / 55 C):						
BTU/Hr. (50 / 60 Hz)	5585 / 6180	5469 / 5965	5300 / 6089	8213 / 8453	7874 / 8063	7311 / 7940
Watts (50 / 60 Hz)	1637 / 1811	1603 / 1748	1553 / 1785	2405 / 2475	2306 / 2361	2143 / 2327
At 95 F / 95 F (35 C / 35 C):						
BTU/Hr. (50 / 60 Hz)	4909 / 5485	5159 / 5621	5572 / 6026	7028 / 7626	6660 / 7411	6448 / 6716
Watts (50 / 60 Hz)	1439 / 1607	1512 / 1647	1633 / 1766	2058 / 2233	1950 / 2170	1890 / 1968
Refrigerant	R134a	R134a	R134a	R134a	R134a	R134a
Refrigerant Charge (ounces/grams)	20 / 567	22 / 624	16 / 454	36 / 1021	36 / 1021	33 / 936
Operating Temperature Range:						
Maximum (°F / °C)	131 / 55	131 / 55	131 / 55	131 / 55	131 / 55	131 / 55
Minimum (°F / °C)	-40 / -40	-40 / -40	-40 / -40	-40 / -40	-40 / -40	-40 / -40
Air Flow at 0 Static Pressure:						
Internal loop 50 Hz (CFM / M ³ /Hr.)	251 / 426	250 / 425	250 / 425	250 / 425	245 / 416	243 / 413
External loop 50 Hz (CFM / M ³ /Hr.)	284 / 483	338 / 574	338 / 574	313 / 532	347 / 589	365 / 620
Internal loop 60 Hz (CFM / M ³ /Hr.)	261 / 443	261 / 443	261 / 443	263 / 447	258 / 439	254 / 432
External loop 60 Hz (CFM / M ³ /Hr.)	311 / 528	356 / 605	356 / 605	338 / 574	382 / 648	394 / 669
Max. Heater W (Outdoor Models)	1300	1300	1300	1300	1300	1300
ELECTRICAL DATA						
Rated Voltage	115	230	400 / 460 3~	115	230	400 / 460 3~
Frequency (Hz)	50 / 60	50 / 60	50 / 60	50 / 60	50 / 60	50 / 60
Operating Range	+/-10%	+/-10%	+/-10%	+/-10%	+/-10%	+/-10%
Max. Power Consumption (Watts at 50 / 60 Hz)	911 / 1108	908 / 1073	697 / 895	1334 / 1530	1265 / 1403	1327 / 1647
Max. Nominal Current (Amps at 50 / 60 Hz)	9.1 / 10.1	4.5 / 4.7	1.59 / 1.69	11.6 / 13.3	5.5 / 6.1	3.0 / 3.3
Starting Current (Amps)	39.2	23.0	8.1	48.3	27.0	16.0
Agency Approvals	cUL Listed CE Others available upon request Terminal Block					
Power Input Description	Terminal Block					
ENCLOSURE PROTECTION						
UL Type	Type 12, 3R, 4 Standard Type 4X Stainless Steel Optional					
CONTROLLER						
Description	Basic Mechanical Thermostat					
Thermostat Location	Enclosure Side					
Factory Thermostat Setting (°F / °C)	80 / 27					
SOUND LEVEL						
At 1.5 Meters	66.9 dBA	66.7 dBA	68.2 dBA	66.0 dBA	66.0 dBA	66.0 dBA
UNIT CONSTRUCTION						
Material	Galvanized sheet metal standard Stainless steel optional					
Finish	RAL 7035 light-gray, semi-textured powder-coat paint standard Other colors available					
ACCESSORIES						
EASYSWAP Adaptor Plenum (GENESIS M36)	Enables SPECTRACOOOL to be mounted to a GENESIS M36 air conditioner cutout Catalog Number PLM36N36					
UNIT DIMENSIONS						
Height (in. / mm)	36.00 / 914.4					
Width (in. / mm)	11.50 / 292.1					
Depth (in. / mm)	14.00 / 355.6					
Weight (lb. / kg)	100 / 45	100 / 45	104 / 47	106 / 48	106 / 48	114 / 52

*Units with Remote Access Control utilize a digital controller and communicate via EtherNet/IP, Profinet, Modbus TCP/IP and SNMP over ethernet or modbus RTU over USB.

Performance Curves for N36 Models 6000 BTU/Hr. (1758 Watt)

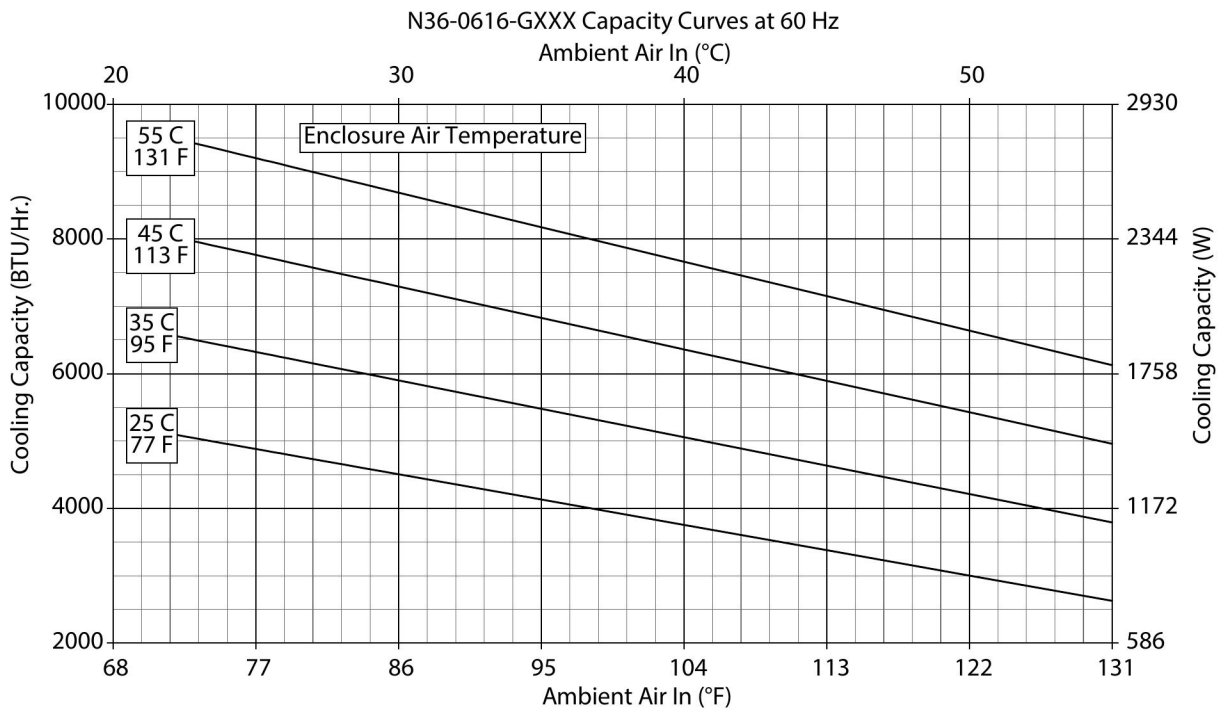
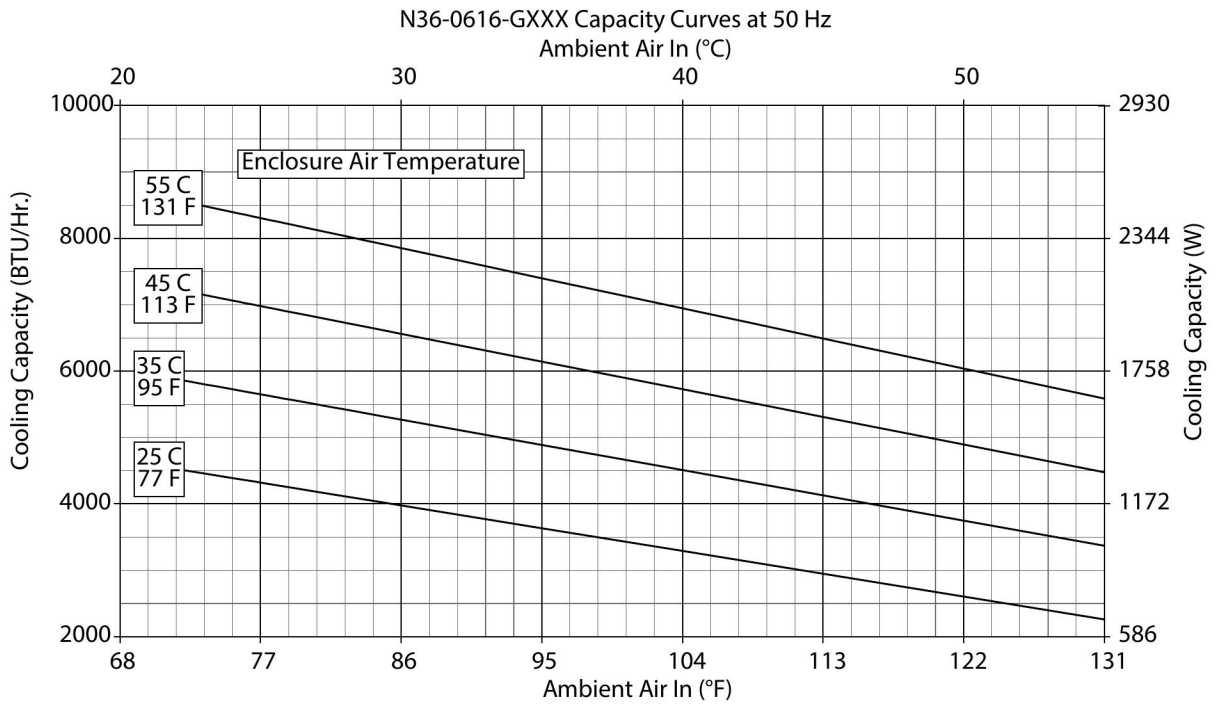

Performance Curves for N36 Models 6000 BTU/Hr. (1758 Watt)

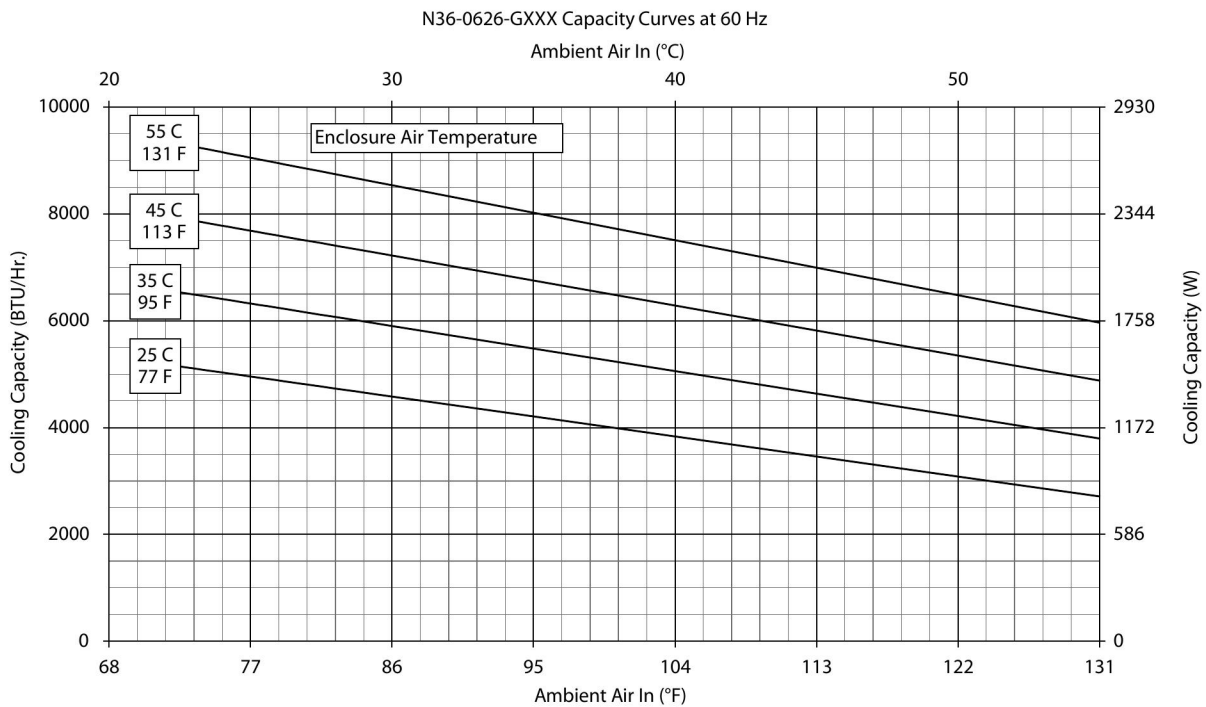
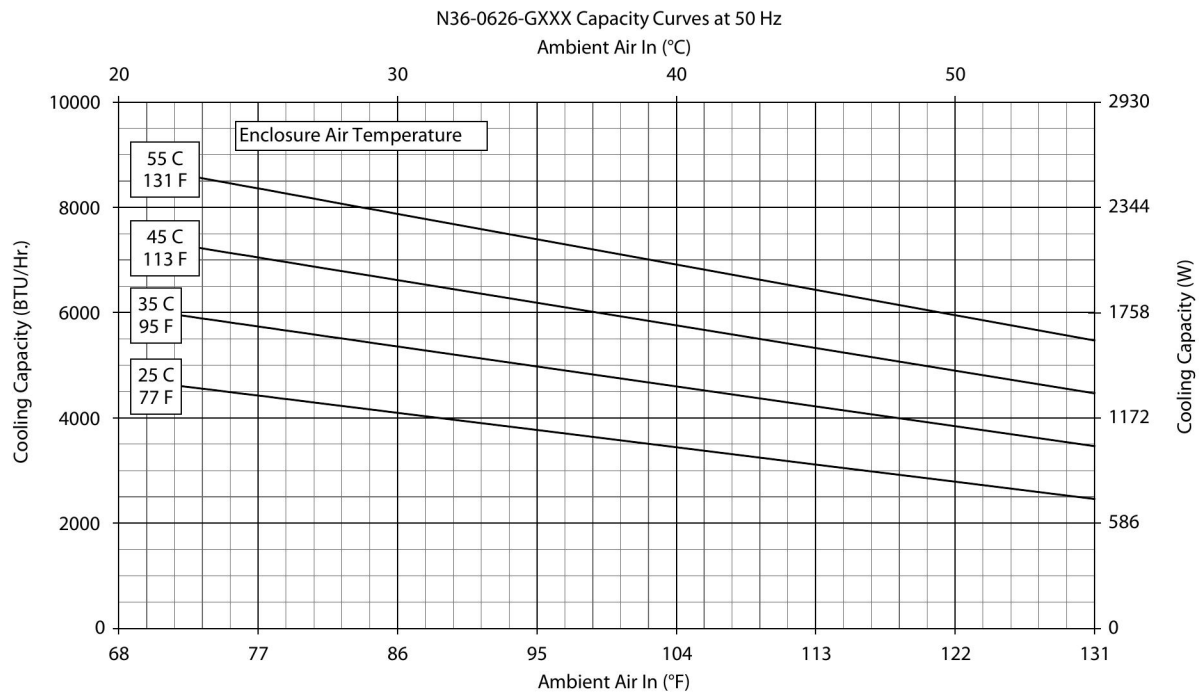

Performance Curves for N36 Models 6000 BTU/Hr. (1758 Watt)

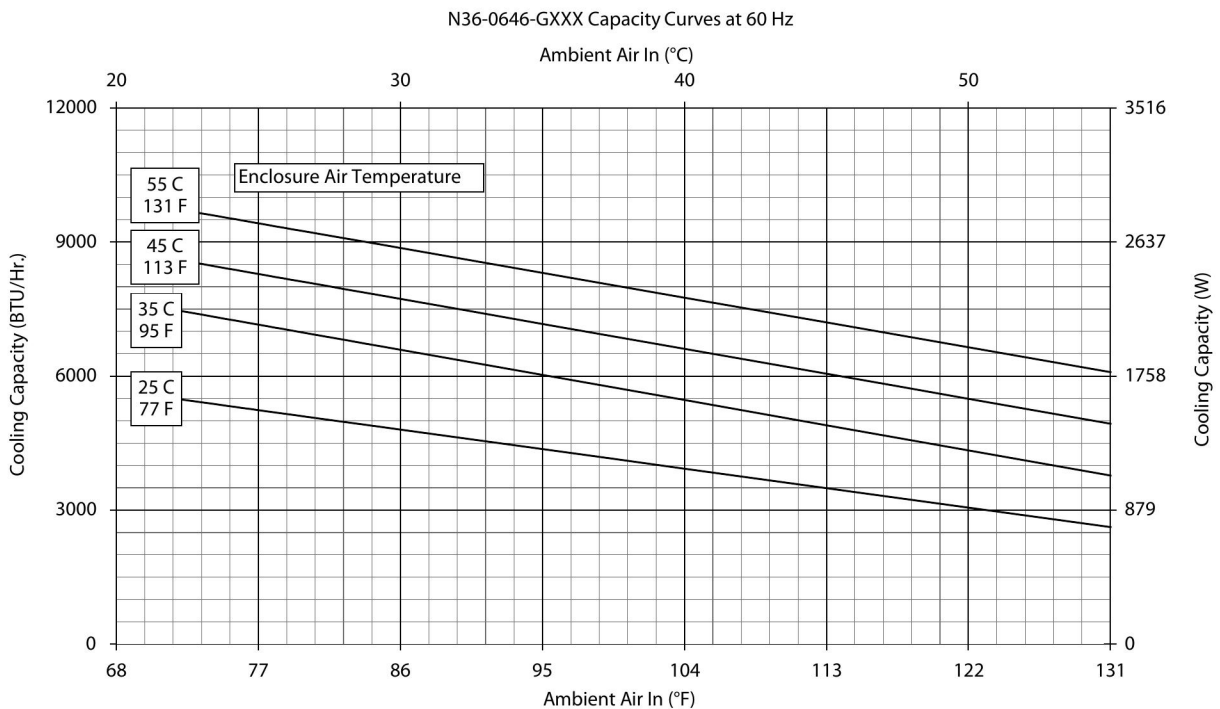
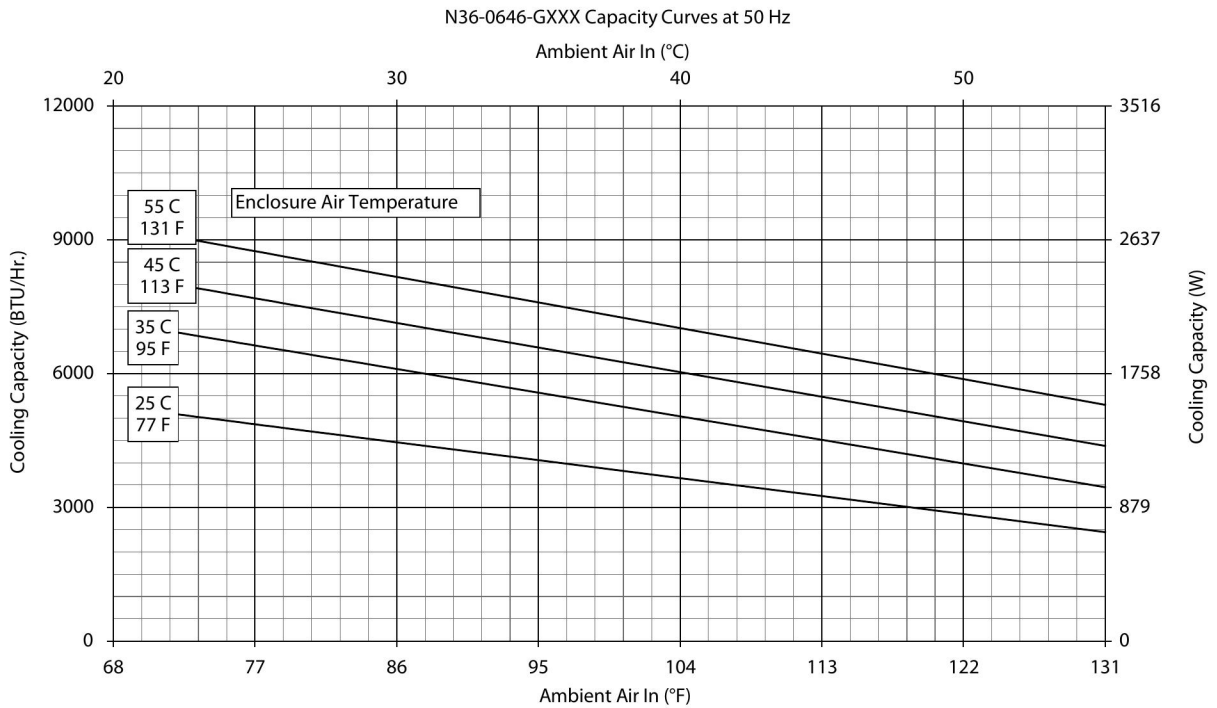

Performance Curves for N36 Models 8000 BTU/Hr. (2344 Watt)

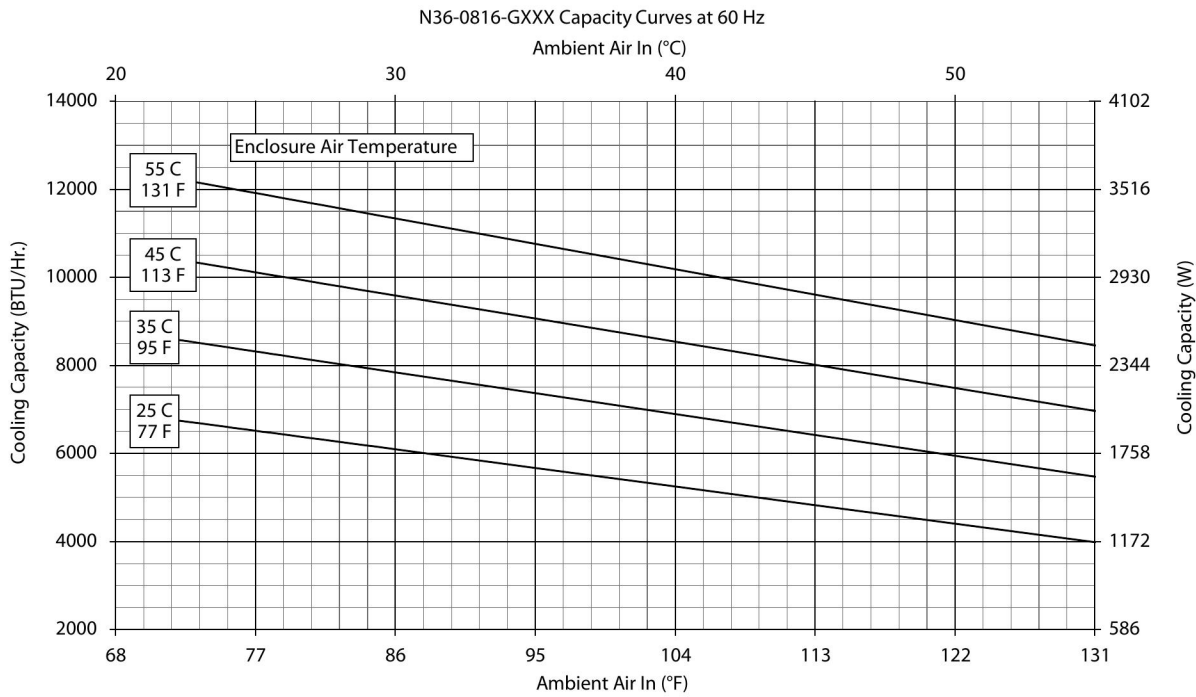
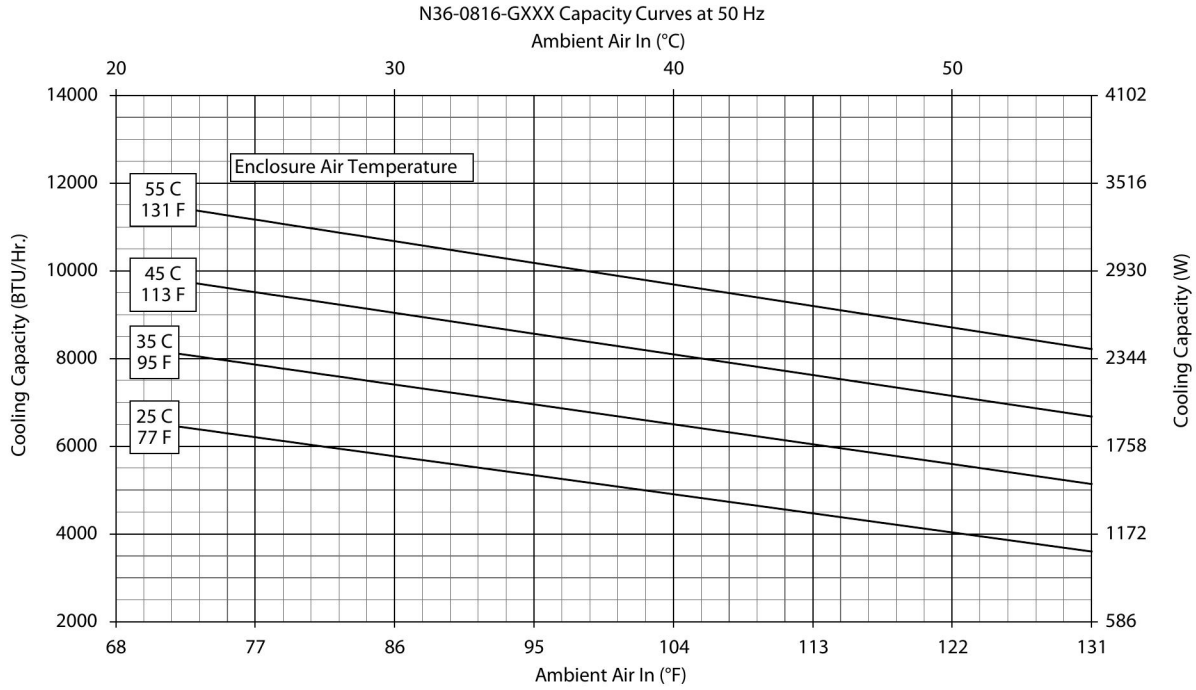

Performance Curves for N36 Models 8000 BTU/Hr. (2344 Watt)

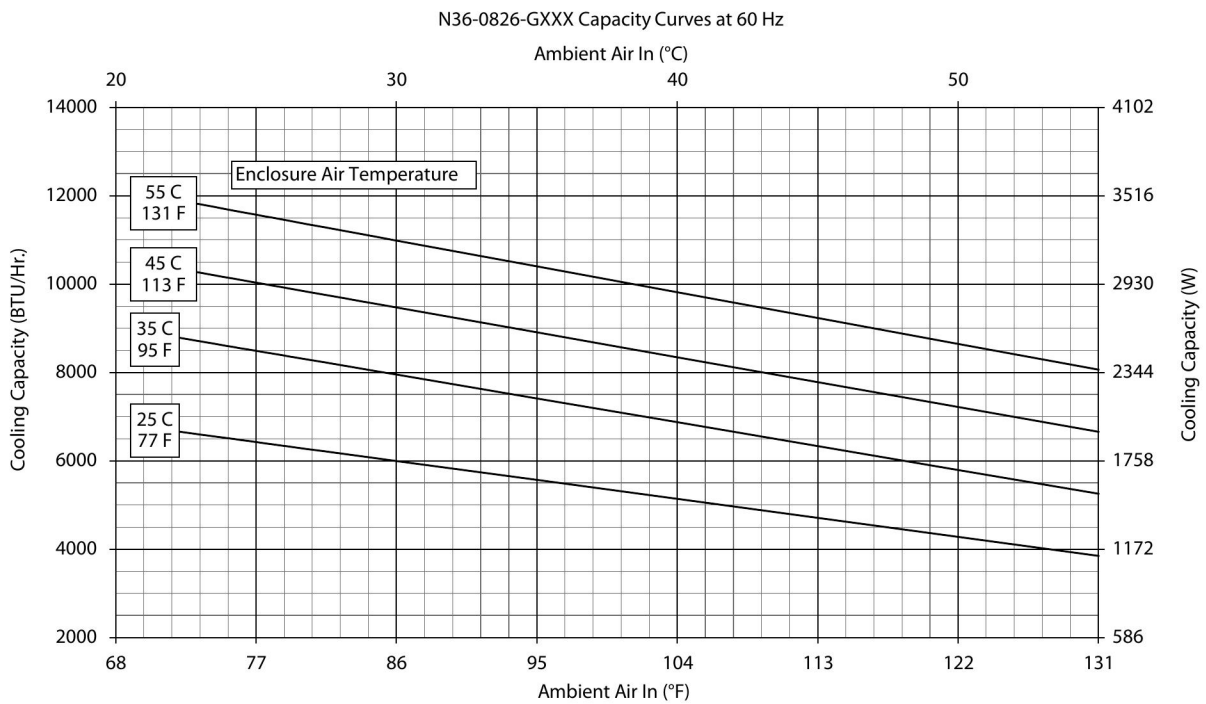
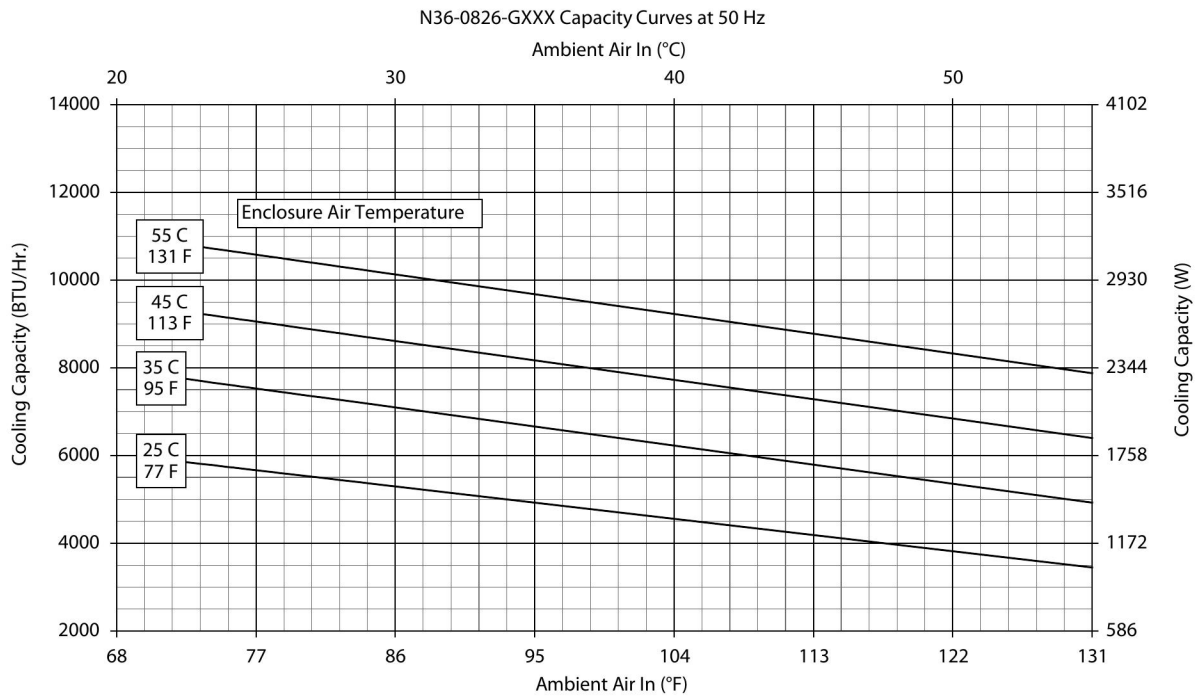

Performance Curves for N36 Models 8000 BTU/Hr. (2384 Watt)

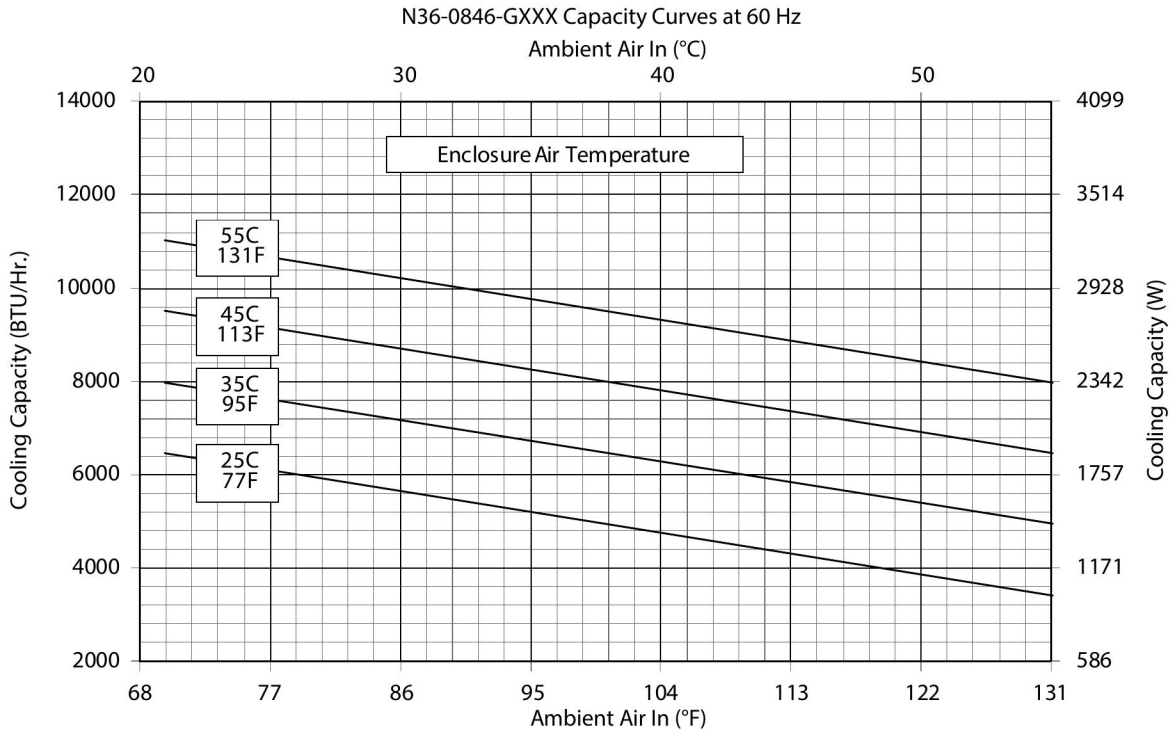
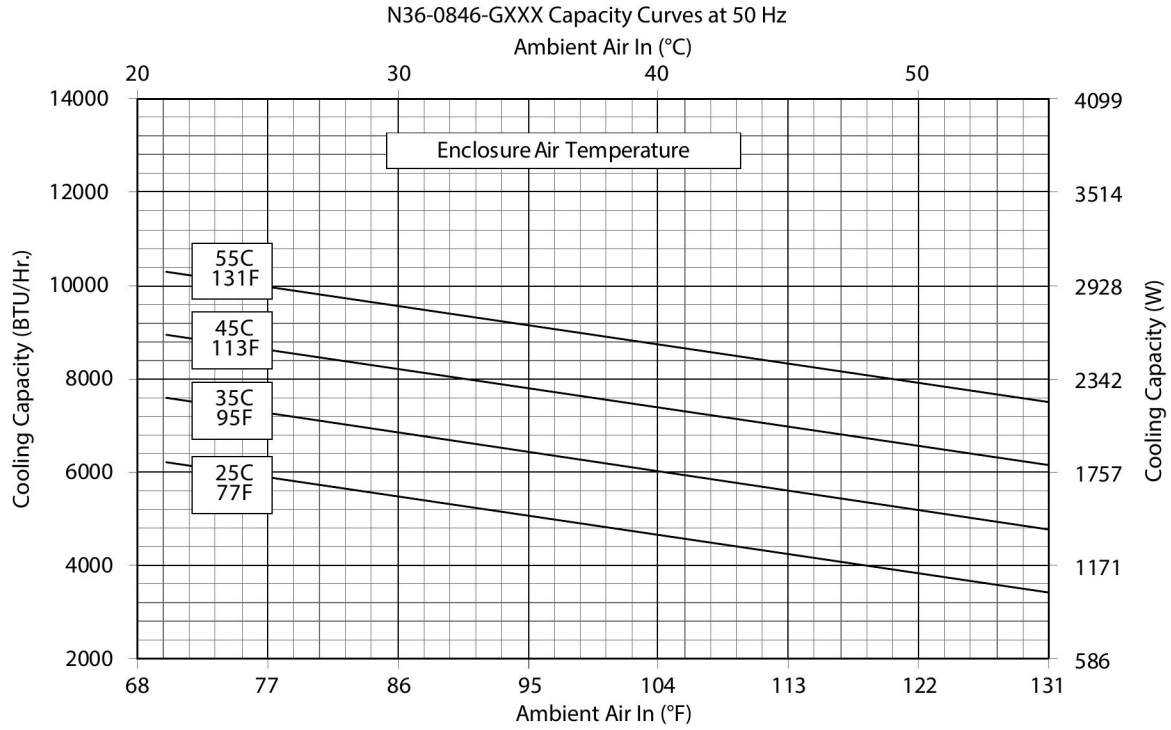

N36 6000/8000 BTU/Hr. (1758/2344 Watt)

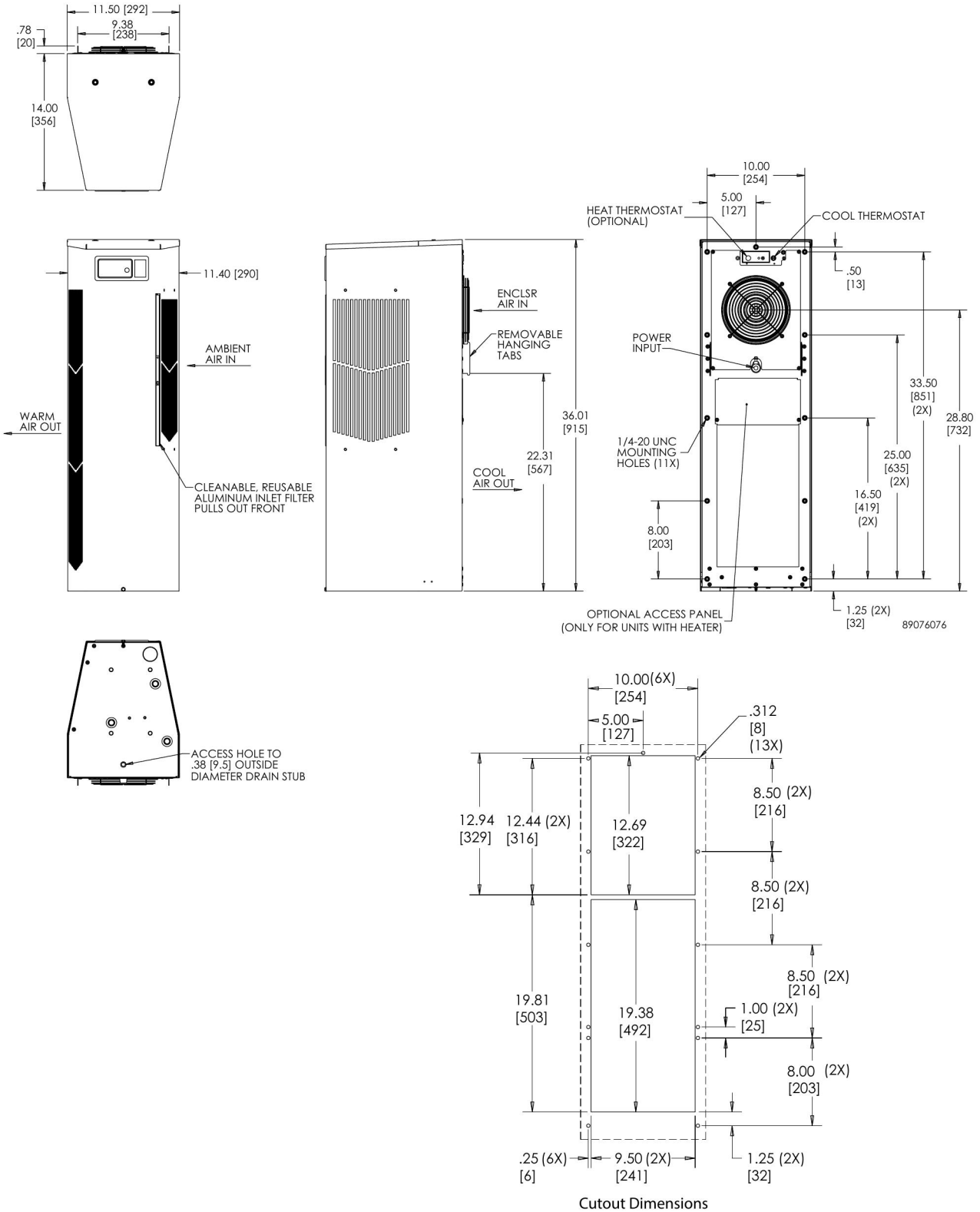

Visit www.nVent.com/HOFFMAN to download 2D and 3D CAD drawings into the overall design of your electrical system.

Performance Data **N43 11000 BTU/Hr. (3223 Watt)**

CATALOG NUMBER			
Indoor Model	N431216G050	N431226G050	N431246G050
Indoor Model Stainless Steel Type 4X	N431216G051	N431226G051	N431246G051
Indoor Model with Remote Access Control*	N431216G060	N431226G060	N431246G060
Outdoor Model without Heat Pkg.	N431216G100	N431226G100	N431246G100
Outdoor Model with Heat Pkg.	N431216G150	N431226G150	N431246G150
Outdoor Model with Heat Pkg. Stainless Steel Type 4X	N431216G151	N431226G151	N431246G151
COOLING PERFORMANCE			
Nominal:			
BTU/Hr.	10400 / 11000	10400 / 11000	10400 / 11000
Watts	3047 / 3223	2900 / 3223	2900 / 3223
At 131 F / 131 F (55 C / 55 C):			
BTU/Hr. (50 / 60 Hz)	10588 / 11180	9664/10420	10864/11756
Watts (50 / 60 Hz)	3103 / 3277	2832/3054	3184/3445
At 95 F / 95 F (35 C / 35 C):			
BTU/Hr. (50 / 60 Hz)	9475 / 10023	8713/9232	9384/10474
Watts (50 / 60 Hz)	2777 / 2937	2554/2706	2750/3069
Refrigerant	R134a	R134a	R134a
Refrigerant Charge (ounces/grams)	36 / 1021	39/1106	43/1219
Operating Temperature Range:			
Maximum (°F / °C)	131 / 55	131 / 55	131 / 55
Minimum (°F / °C)	-40 / -40	-40 / -40	-40 / -40
Air Flow at 0 Static Pressure:			
Internal loop 50 Hz (CFM / M ³ /Hr)	239 / 406	259 / 440	254 / 432
External loop 50 Hz (CFM / M ³ /Hr)	494 / 839	489 / 831	341 / 579
Internal loop 60 Hz (CFM / M ³ /Hr)	250 / 425	267 / 454	260 / 442
External loop 60 Hz (CFM / M ³ /Hr)	528 / 897	525 / 892	564 / 958
Max. Heater W (Outdoor Models)	1300	1300	1300
ELECTRICAL DATA			
Rated Voltage	115	230	400 / 460 3~
Frequency (Hz)	50 / 60	50 / 60	50 / 60
Operating Range	+/-10%	+/-10%	+/-10%
Max. Power Consumption (Watts at 50 / 60 Hz)	1802 / 2446	1762/2226	1678/2107
Max. Nominal Current (Amps at 50 / 60 Hz)	16.6 / 22.0	7.9/10.2	3.4/3.6
Starting Current (Amps)	57	30/28	20/18
Agency Approvals		cUL Listed CE	
Power Input Description		Others available upon request	
ENCLOSURE PROTECTION		Terminal Block	
UL Type		Type 12, 3R, 4 Standard Type 4X Stainless Steel Optional	
CONTROLLER			
Description		Basic Mechanical Thermostat	
Thermostat Location		Enclosure Side	
Factory Thermostat Setting (°F / °C)		80 / 27	
SOUND LEVEL			
At 1.5 Meters	68.4 dBA	68.4 dBA	69.6 dBA
UNIT CONSTRUCTION			
Material		Galvanized sheet metal standard Stainless steel optional	
Finish		RAL 7035 light-gray, semi-textured powder-coat paint standard Other colors available	
UNIT DIMENSIONS			
Height (in / mm)		43.00 / 1092.2	
Width (in / mm)		11.50 / 292.1	
Depth (in / mm)		14.00 / 355.6	
Weight (lb / kg)	127/57.6	127/57.6	138/62.6

*Units with Remote Access Control utilize a digital controller and communicate via EtherNet/IP, Profinet, Modbus TCP/IP and SNMP over ethernet or modbus RTU over USB.

Performance Curves for N43 Models 11000 BTU/Hr. (3223 Watt)

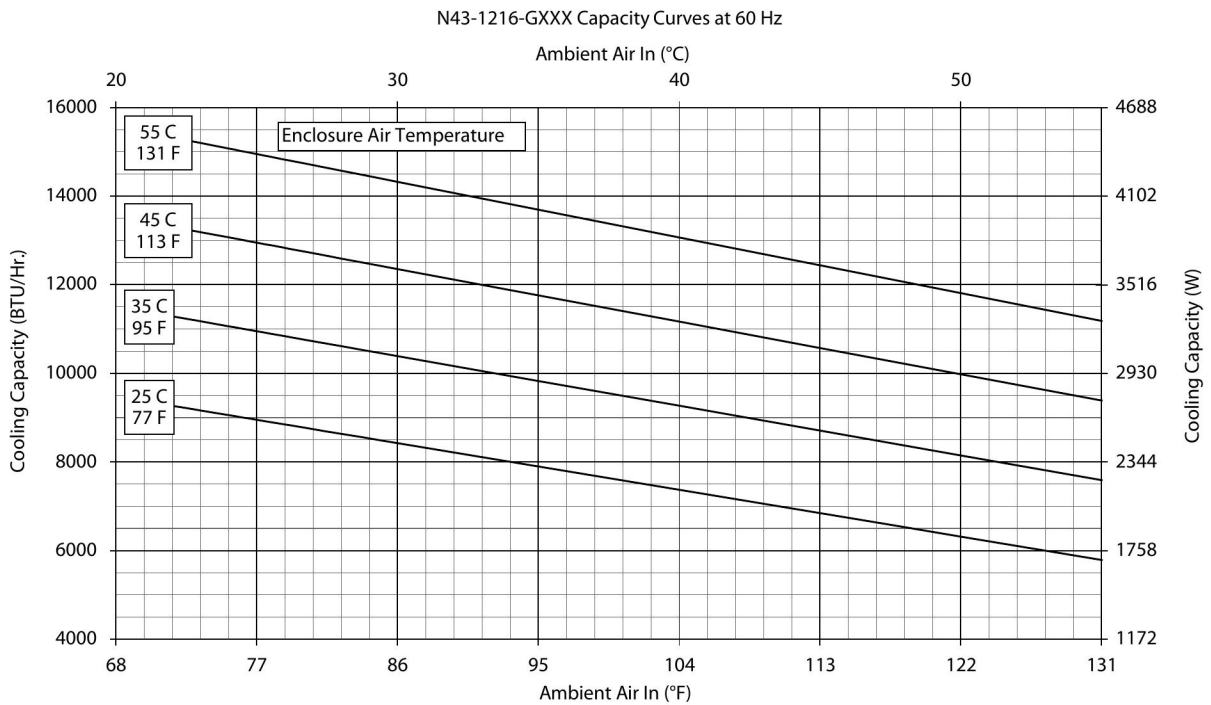
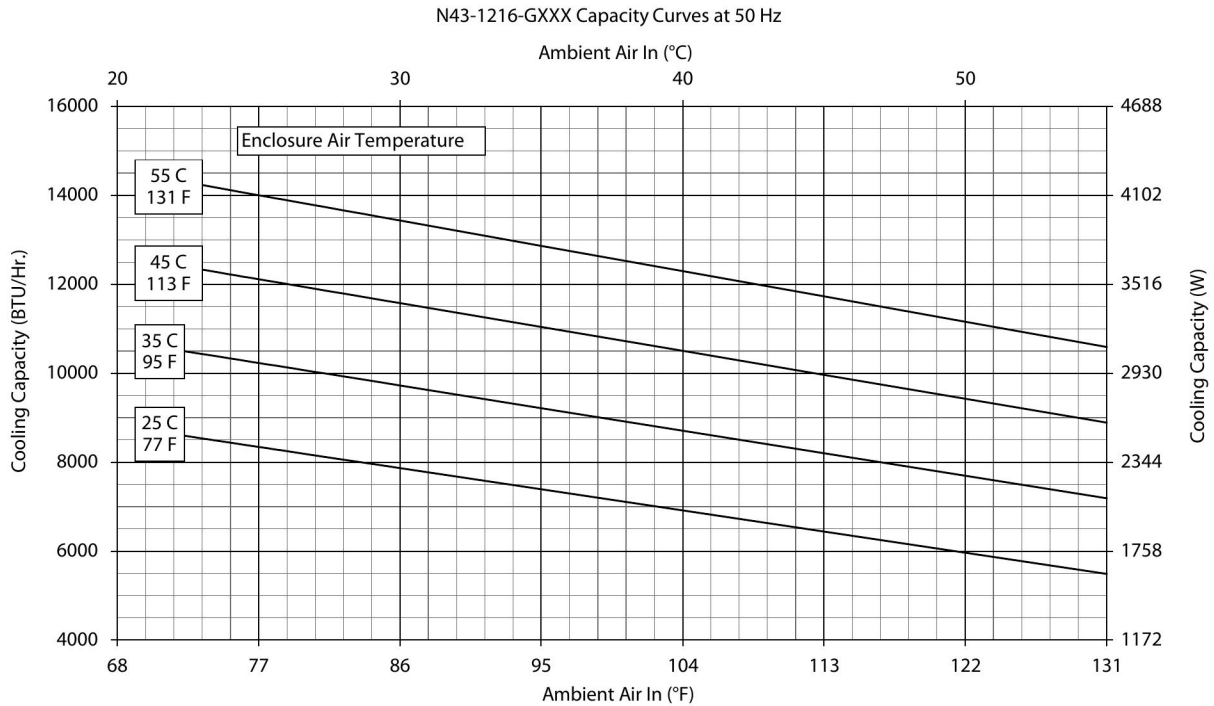

Performance Curves for N43 Models 11000 BTU/Hr. (3223 Watt)

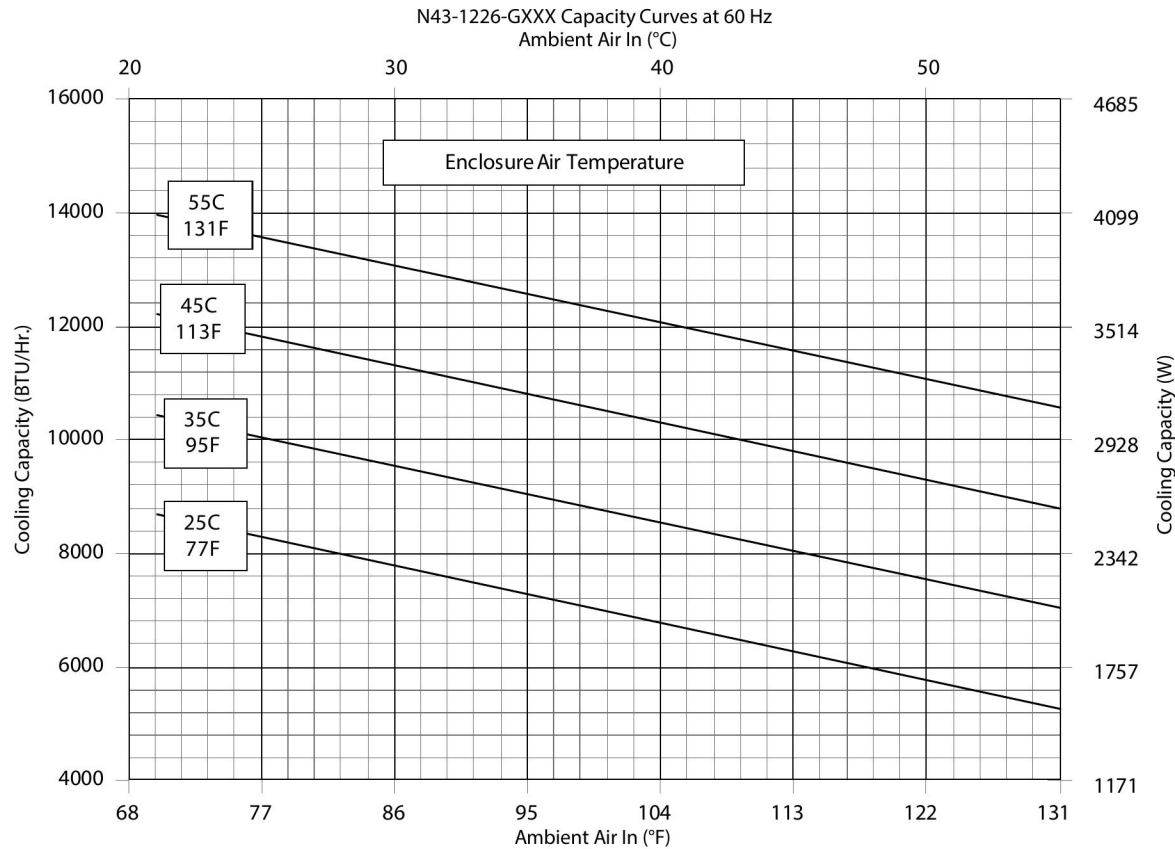
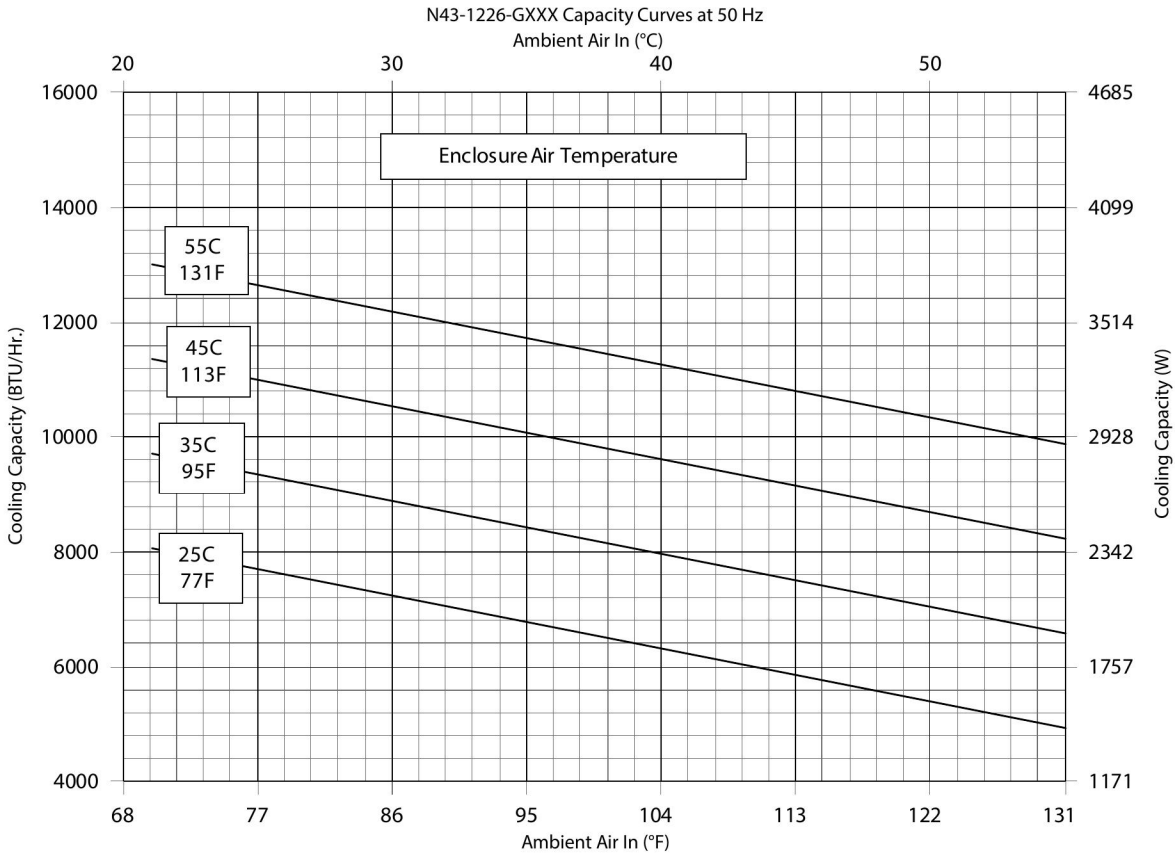

Performance Curves for N43 Models 11000 BTU/Hr. (3223 Watt)

N43-1246-GXXX Capacity Curves at 50 Hz

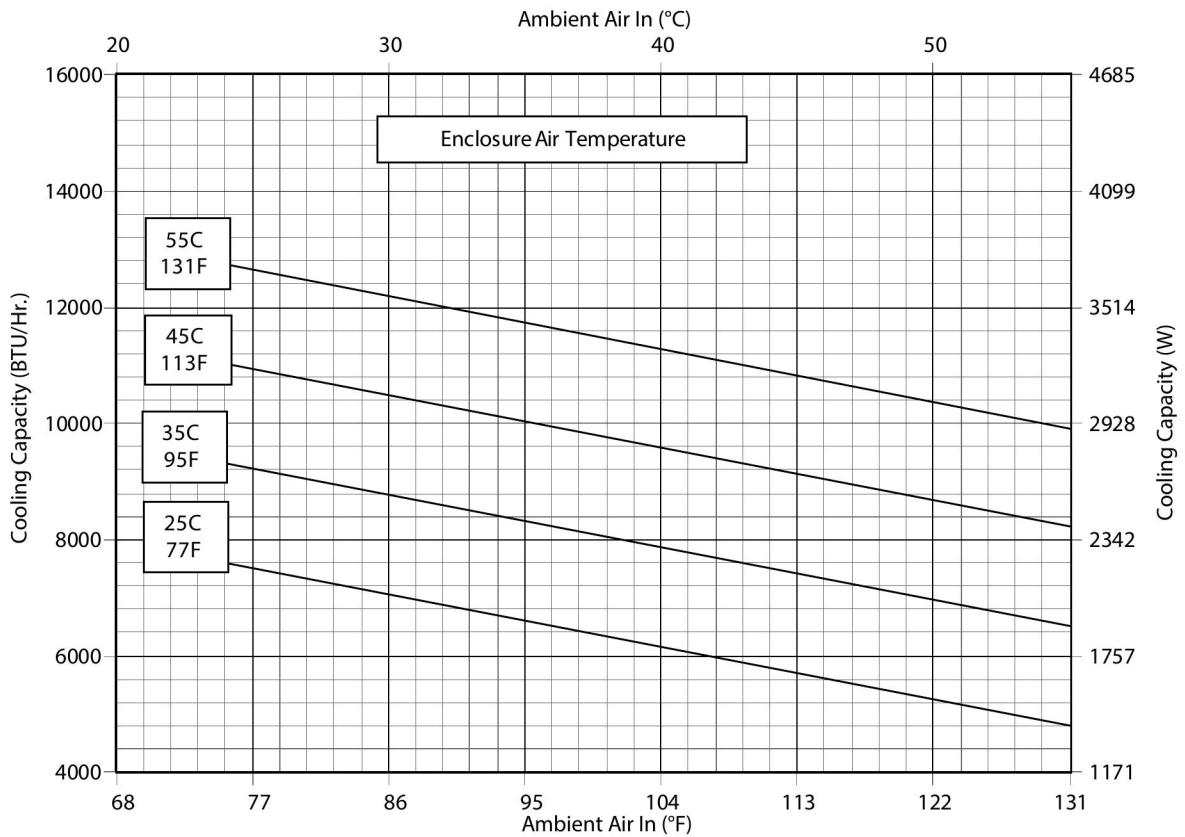

N43-1246-GXXX Capacity Curves at 60 Hz

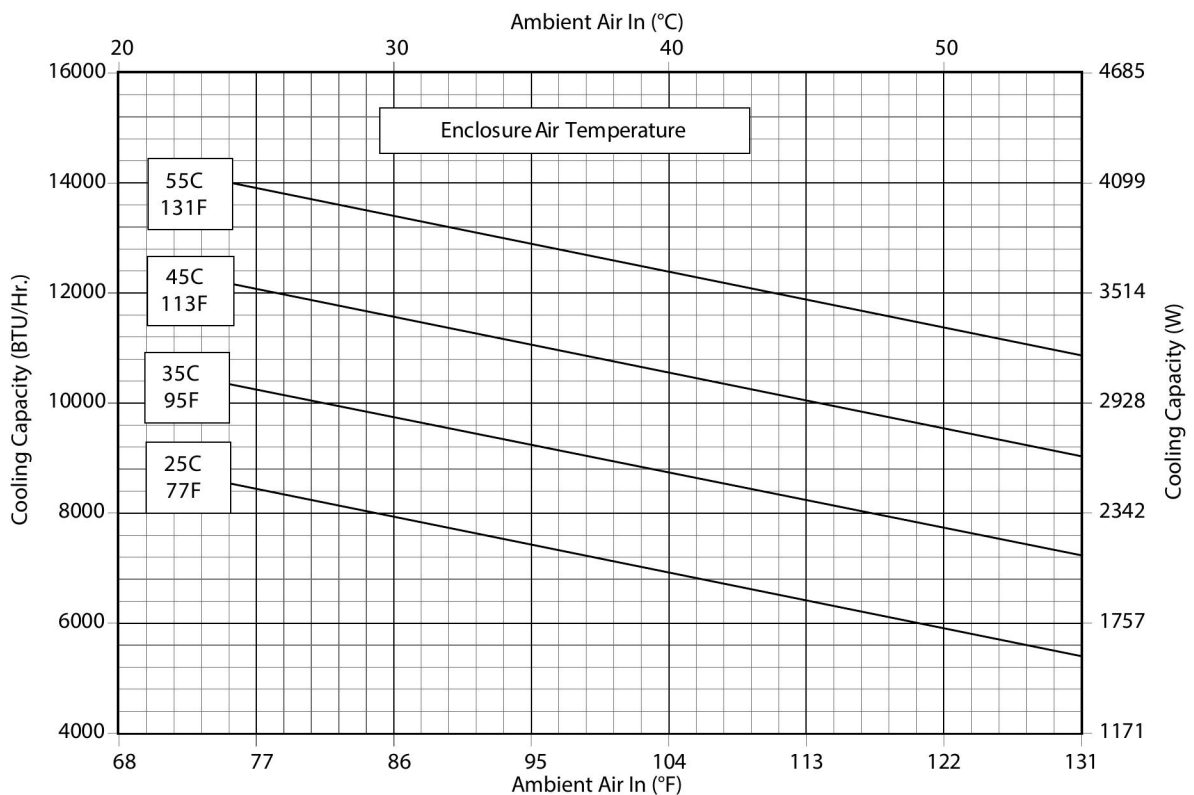

Visit www.nVent.com/HOFFMAN to download 2D and 3D CAD drawings into the overall design of your electrical system.

N43 12000 BTU/Hr. (3516 Watt)

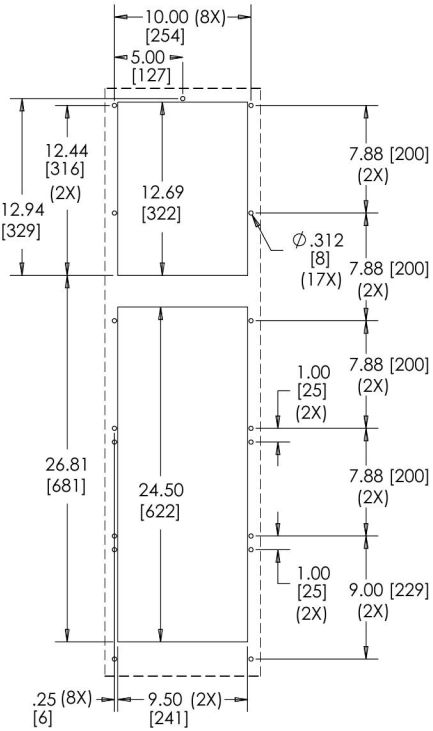
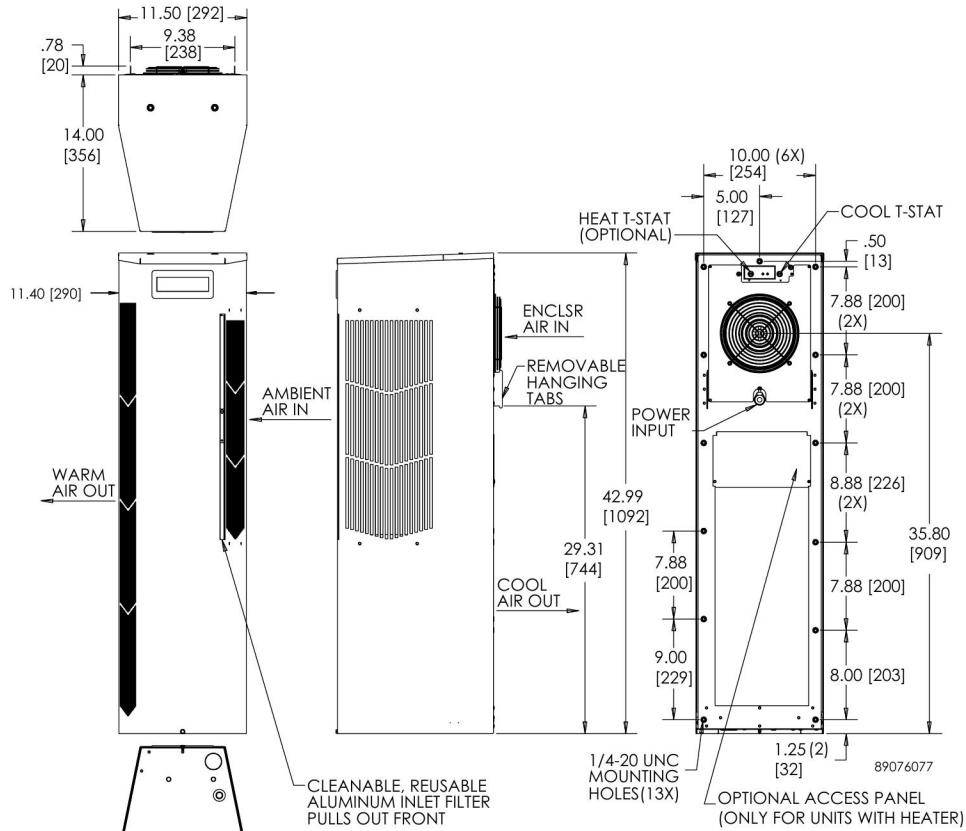

CUTOUT INSTRUCTIONS